



Clemas
CLEANING MACHINES

T17

(Battery)

Rider Scrubber
English (EN)
Operator Manual

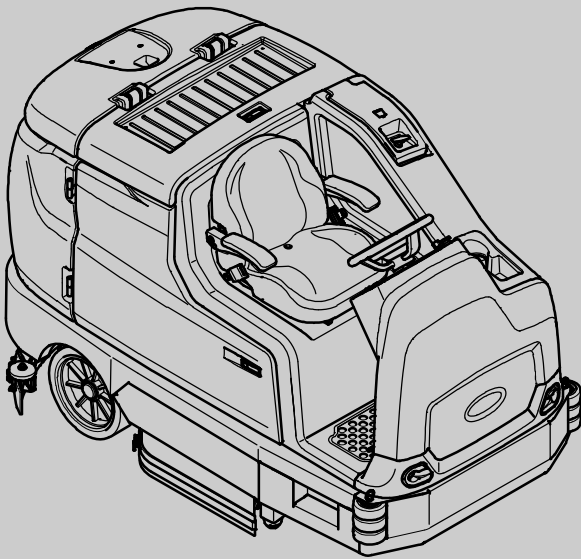

ES[®] Extended Scrub System
TennantTrue[®] Parts
IRIS[®] a Tennant Technology



INTRODUCTION

This manual is furnished with each new model. It provides necessary operation and maintenance instructions.



Read this manual completely and understand the machine before operating or servicing it.

This machine will provide excellent service. However, the best results will be obtained at minimum costs if:

- The machine is operated with reasonable care.
- The machine is maintained regularly - per the machine maintenance instructions provided.
- The machine is maintained with manufacturer supplied or equivalent parts.

PROTECT THE ENVIRONMENT	MACHINE DATA
	Please fill out at time of installation for future reference.
Please dispose of packaging materials, used components such as batteries and fluids in an environmentally safe way according to local waste disposal regulations.	Model No. – _____
	Serial No. – _____
Always remember to recycle.	Installation Date – _____

INTENDED USE

The T17 is an industrial/commercial rider machine designed to wet scrub both rough and smooth hard surfaces (concrete, tile, stone, synthetic, etc). Typical applications include schools, hospitals / health care facilities, office buildings, and retail centers. Do not use this machine on soil, grass, artificial turf, or carpeted surfaces. This machine is intended for indoor use only. This machine is not intended for use on public roadways. Do not use this machine other than described in this Operator Manual.

Specifications and parts are subject to change without notice.

CONTENTS

	Page		Page
Important Safety Instructions –		Filling The Solution Tank	45
Save These Instructions	4	Conventional Scrubbing Mode	45
Operation	10	Ec-H2o Scrubbing (Ec-H2o Mode) ...	45
Machine Components	10	Es (Extended Scrub) Mode –	
Controls And Instruments	12	Manual Tank Fill	46
Touch Panel	14	Auto-Fill (Option)	46
Pro-Panel Controls	16	Ec-H2o Button (Option)	47
Symbol Definitions	18	Es (Extended Scrub) Button (Option)	48
Operation Of Controls	22	Scrub Brush Pressure	49
Battery Discharge Indicator	22	Setting Scrub Brush Pressure –	
Hour Meter	22	Standard Panel	49
Recovery Tank Full Indicator	22	Setting Scrub Brush Pressure –	
Solution Tank Indicator	23	Pro-Panel	49
Contrast Control Button	23	Solution Flow	50
Configuration Mode Button	23	Setting Solution Flow – Standard Panel	50
1-Step Button	23	Setting Solution Flow – Pro-Panel	50
Side Brush Button (Option)	24	Scrubbing – Standard Panel	51
Vacuum Fans / Squeegee Button	24	Scrubbing – Pro-Panel	52
Scrubbing Main Brush Button	24	Double Scrubbing	53
Solution On / Off Button	24	Water Pickup Mode (No Scrubbing)	55
Severe Environment Switch (Option) ..	25	Stop Scrubbing	55
Detergent Metering (Option)	25	Draining And Cleaning The Recovery Tank	56
Pre-Sweep Switch (Option)	26	Draining And Cleaning The Solution Tank .	59
Operation Of Controls – Pro-Panel	27	Turn Off The Machine	60
Pro-Id Login Screen	27	Fault Indicators	61
Machine Status Button	27	Warning Codes / Warning Codes	62
Changing The Default Button	28	Fault / Alert Indicators – Standard Panel	62
1-Step Button	28	Fault / Alert Indicators – Pro-Panel ...	62
Scrubbing Main Brush Button	29	Fault / Warning Codes	
Scrubbing Vacuum Fan /		(S/N 0000–1199)	63
Squeegee Button	29	Fault / Warning Codes	
Scrubbing Side Brush Button (Option) .	29	(S/N 01200–)	66
Sweeping Side Brush	29	Options	67
Pre-Sweep Brush Button	30	Spray Nozzle (Option)	67
Pre-Sweep Vacuum Fan Button	30	High Pressure Washer (Option)	68
Solution On / Off Button	30	Priming The High Pressure	
Screen Lock	30	Washer Pump	71
Severe Environment Switch (Option) ..	31	Wet Vacuum Wand (Option)	71
Detergent Metering (Option)	31	Live Wand (Option)	73
Zone Control Buttons	32	Operating The Live Wand	
Rearview Camera Button	33	(Off Machine)	73
Help Button	33	Operating The Live Wand	
Video Help Button	33	(On Machine)	73
Completeing The Pro-Check		Emptying The Live Wand	
Pre-Operation Checklist	36	Vacuum Debris Tray	74
Operation Of Controls – All Machines	37	Clean The Live Wand Vacuum Filter ...	75
Emergency Shut-Off Button	37	Rear Squeegee Guard (Option)	76
Directional Switch	37	Scrubbing Or Sweeping Side Brush	
Operating / Hazard Light Switch (Option)	37	(Option)	76
Propel Pedal	38	Pre-Sweep Assembly (Option)	77
Brake Pedal	38	Operate Pre-Sweep (Option) With	
Parking Brake Pedal	38	Standard Panel	77
Operator Seat	38	Operate Pre-Sweep (Option) With	
Seat Belts (Deluxe Seat Option Only) .	38	Pro-Panel	77
Rear Bumper Door / Step	39	Empty The Pre-Sweep Debris Hopper	78
How The Machine Works	40	Adjusting Backup Alarm Volume	
Brush And Pad Information	41	(Option)	79
While Operating The Machine	42	Slide Out Battery (Option)	80
Pre-Operation Checklist	43	Machine Troubleshooting	81
Starting The Machine	44		
Filling The Detergent Tank (Option)	44		

CONTENTS

	Page		Page
Maintenance	84	Machine Jacking	119
Maintenance Chart	85	Ec-H2o Module Flush Procedure	120
Yellow Touch Points	87	Storage Information	122
Lubrication	87	Freeze Protection	122
Steering Chain	87	Preparing The Machine For Operation	
Steering Gear Chain	87	After Storage	124
Drive Wheel Pivot	87	Priming The Ec-H2o System	126
Drive Wheel Motor	87	Specifications	128
High Pressure Washer Oil	88	General Machine Dimensions/Capacities	128
Batteries	89	General Machine Performance	129
Checking The Electrolyte Level	89	Power Type	129
Maintenance-Free Batteries	89	Tires	130
Checking Connections / Cleaning	89	Scrubbing Side Brush Solution	
Charging The Batteries	90	Flow Rate (Option)	130
Battery Charger Usb Port	92	Ec-H2o System (Option)	130
Battery Watering System (Option)	93	High Pressure Washer (Option)	130
Circuit Breakers, Fuses, And Relays	94	Machine Dimensions	131
Circuit Breakers	94	Supervisor Controls	132
Fuses	95	Pro-Panel Supervisor Controls	132
Relays	95	Entering The Supervisor Mode -	
Electric Motors	95	First Time Use Only	132
Solution Supply Filter	95	Entering The Supervisor Mode	133
Scrub Brushes	96	Supervisor Setting Screen / Screen Icons	134
Disk Brushes And Pads	96	Adding / Editing Profiles	135
Replacing Disk Brushes Or		Enabling The Login	137
Pad Drivers	96	Disabling The Login	138
Replacing Disk Scrub Pads	97	Changing The Battery Type	139
Cylindrical Brushes	98	Calibrating The Touch	139
Replacing Cylindrical Scrub Brushes	98	Exporting Checklists	140
Side Brush(Es) (Option)	98	Checklist Setup	141
Replacing The Scrubbing Side Brush .	100	Disabling / Enabling The Pre-Operation	
Replacing The Sweeping Side		Checklist	142
Brush(Es)	100	Changing The Rear View Camera Settings	143
Pre-Sweep Brushes (Optional)	102	Programming The Zone Control Buttons .	143
Replacing The Pre-Sweep		Setting / Changing The Date And Time ..	145
Side Brushes	102	Setting / Changing The Screen Lock	146
Replacing The Pre-Sweep			
Cylindrical Brush	103		
Squeegee Blades	105		
Replacing (Or Rotating) The Rear			
Squeegee Blades	105		
Leveling The Rear Squeegee	109		
Adjusting The Rear Squeegee Blade			
Deflection	110		
Replacing Or Rotating The Side			
Squeegee Blades	111		
Replacing Or Rotating The Side Brush			
Squeegee Blades (Option)	112		
Skirts And Seals	114		
Recovery Tank Seal	114		
Solution Tank Seal	114		
Live Wand Vacuum Seals (Option) ...	114		
Scrub Head Skirts			
(Disk Scrub Heads Only)	115		
Pre-Sweep Skirts (Option)	115		
Belts	116		
Cylindrical Brush Drive Belts	116		
Pre-Sweep Brush Drive Belt (Option)	116		
Brakes	116		
Tires	116		
Pushing, Towing, And Transporting			
The Machine	117		
Pushing Or Towing The Machine	117		
Transporting The Machine	117		

IMPORTANT SAFETY INSTRUCTIONS – SAVE THESE INSTRUCTIONS

The following precautions are used throughout this manual as indicated in their description:

 **WARNING: To warn of hazards or unsafe practices that could result in severe personal injury or death.**

FOR SAFETY: To identify actions that must be followed for safe operation of equipment.

The following information signals potentially dangerous conditions to the operator. Know when these conditions can exist. Locate all safety devices on the machine. Report machine damage or faulty operation immediately.

 **WARNING: Batteries emit hydrogen gas. Explosion or fire can result. Keep sparks and open flame away. Keep covers open when charging.**

 **WARNING: Flammable materials can cause an explosion or fire. Do not use flammable materials in tank(s).**

 **WARNING: Flammable materials or reactive metals can cause an explosion or fire. Do not pick up.**

 **WARNING: Heavy object. Back injury could result from improper lifting. Use hoist when removing.**

 **WARNING: Do not spray people or animals. Severe personal injury can result. Wear eye protection. Hold sprayer with two hands.**

 **WARNING: Electrical Hazard**

- Disconnect Battery Cables and Charger Plug Before Servicing Machine.
- Do Not Charge Batteries with Damaged Power Supply Cord. Do Not Modify Plug.

If the charger supply cord is damaged or broken, it must be replaced by the manufacturer or its service agent or a similarly qualified person in order to avoid a hazard.

This machine may be equipped with technology that automatically communicates over the cellular network. If this machine will be operated where cell phone use is restricted because of concerns related to equipment interference, please contact a Tennant representative for information on how to disable the cellular communication functionality.

FOR SAFETY:

1. **Do not operate machine:**
 - Unless trained and authorized.
 - Unless operator manual is read and understood.
 - Under the influence of alcohol or drugs.
 - While using a cell phone or other types of electronic devices.
 - Unless mentally and physically capable of following machine instructions.
 - With brake disabled.
 - If it is not in proper operating condition.
 - With pads or accessories not supplied or approved by Tennant. The use of other pads may impair safety.
 - In outdoor areas. This machine is for indoor use only.
 - In areas where flammable vapors/liquids or combustible dusts are present.
 - In areas that are too dark to safely see the controls or operate the machine unless operating / headlights are turned on.
 - In areas with possible falling objects unless equipped with overhead guard.
 - With the rear bumper door / step in the lowered position.
2. **Before starting machine:**
 - Check machine for fluid leaks.
 - Make sure all safety devices are in place and operate properly.
 - Check brakes and steering for proper operation.
 - Check parking brake pedal for proper operation.
 - Adjust seat and fasten seat belt (if equipped).

3. When using machine:

- Use only as described in this manual.
- Use brakes to stop machine.
- Go slowly on inclines and slippery surfaces.
- Base machine: Do not scrub on ramp inclines that exceed 8.7% / 5° grade or transport (GVWR) on ramp inclines that exceed 12% / 7° grade.
- Machine with ramp kit: Do not scrub on ramp inclines that exceed 10.5% / 6° grade or transport (GVWR) on ramp inclines that exceed 14.8% / 8.5° grade.
- Reduce speed when turning.
- Keep all parts of body inside operator station while machine is moving.
- Always be aware of surroundings while operating machine.
- Do not access the video / help screens while the machine is moving. (Pro-Panel)
- Use care when reversing machine.
- Keep children and unauthorized persons away from machine.
- Do not carry passengers on any part of the machine.
- Always follow safety and traffic rules.
- Report machine damage or faulty operation immediately.
- Follow mixing, handling and disposal instructions on chemical containers.
- Follow site safety guidelines concerning backup alarms.
- Follow site safety guidelines concerning wet floors.
- Do not leave machine unattended when filling solution tank with auto-fill feature.
- Park machine on level surface when filling solution tank with auto-fill feature.

4. Before leaving or servicing machine:

- Stop on level surface.
- Set parking brake.
- Turn off machine and remove key.

5. When servicing machine:

- All work must be done with sufficient lighting and visibility.
- Keep work area well ventilated.
- Avoid moving parts. Do not wear loose clothing, jewelry and secure long hair.
- Block machine tires before jacking machine up.
- Jack machine up at designated locations only. Support machine with jack stands.
- Use hoist or jack that will support the weight of the machine.
- Do not push or tow the machine without an operator in the seat controlling the machine.

- Do not push or tow the machine on inclines with the brake disabled.
- Do not power spray or hose off machine near electrical components.
- Disconnect battery connections and charger cord before working on machine.
- Do not pull on battery charger cord to unplug. Grasp plug at outlet and pull.
- Do not use incompatible battery chargers as this may damage battery packs and potentially cause a fire.
- Inspect charger cord regularly for damage.
- Do not disconnect the off-board charger's DC cord from the machine receptacle when the charger is operating. Arcing may result. If the charger must be interrupted during charging, disconnect the AC power supply cord first.
- Avoid contact with battery acid.
- Keep all metal objects off batteries.
- Use a non-conductive battery removal device.
- Use a hoist and adequate assistance when lifting batteries.
- Battery installation must be done by trained personnel.
- Follow site safety guidelines concerning battery removal.
- All repairs must be performed by a trained service mechanic.
- Do not modify the machine from its original design.
- Use Tennant supplied or approved replacement parts.
- Wear personal protective equipment as needed and where recommended in this manual.



For Safety: wear hearing protection.



For Safety: wear protective gloves.



For Safety: wear eye protection.



For Safety: wear protective dust mask.

SAFETY PRECAUTIONS

- 6. When loading/unloading machine onto/off truck or trailer.**
 - **Use ramp, truck or trailer that will support the weight of the machine and operator.**
 - **Drain tanks before loading machine.**
 - **Do not drive on slippery ramp.**
 - **Use caution when driving on ramp.**
 - **Do not load/unload on ramp inclines that exceed 21% / 12° grade.**
 - **Lower scrub head and squeegee before tying down machine.**
 - **Stop on a level surface, set parking brake and leave the key in the ON position until all tie-down straps are secure.**
 - **Block machine tires.**
 - **Tie machine down to truck or trailer.**

The safety labels appear on the machine in the locations indicated. Replace damaged labels.

WARNING LABEL –
Batteries emit hydrogen
gas. Explosion or fire can
result. Keep sparks and
open flame away. Keep
covers open when charging.

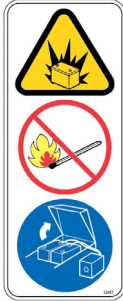

Located on bottom of battery compartment cover.

WARNING LABEL – Flammable
materials can cause explosion or
fire. Do not use flammable materials
in tank.



Located on solution tank cover and on detergent tank (option).

WARNING LABEL – Flammable
materials or reactive metals
can cause explosion or fire.
Do not pick up.



Located on electrical panel.

FOR SAFETY LABEL –
Do not operate
machine with rear
bumper door / step in
the lowered position.
Do not carry
passengers on any
part of the machine.



Located on rear bumper door / step.

FOR SAFETY LABEL –
Read manual before
operating machine.



Located on electrical panel.

FOR SAFETY LABEL –
Authorized Service
Mechanic
Only.



Located on circuit board cover and electrical panel.

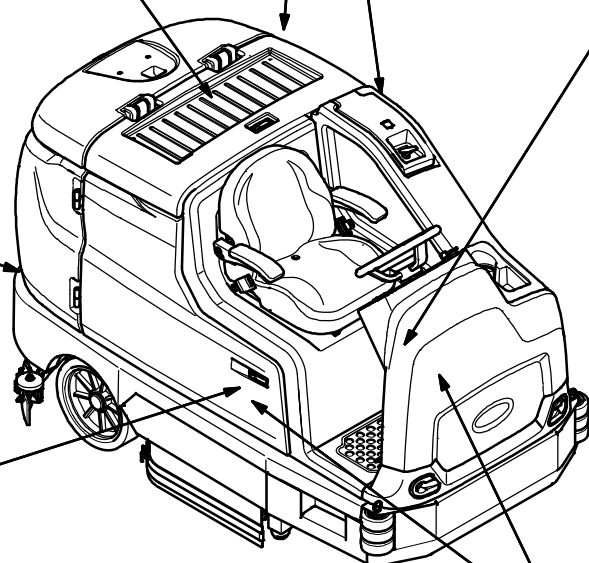

SAFETY PRECAUTIONS

WARNING LABEL – Heavy object. Back injury could result from improper lifting. Use hoist when removing.



Located under high pressure washer cover.

WARNING LABEL – Do not spray people or animals. Severe personal injury can result. Wear eye protection. Hold sprayer with two hands.



Located on high pressure washer cover.

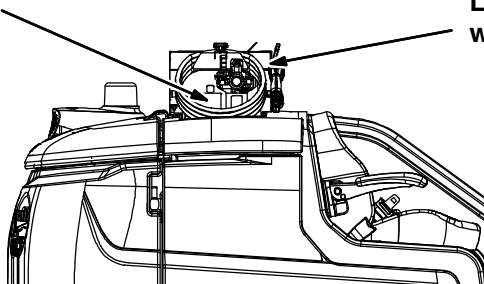

356408

MACHINE COMPONENTS

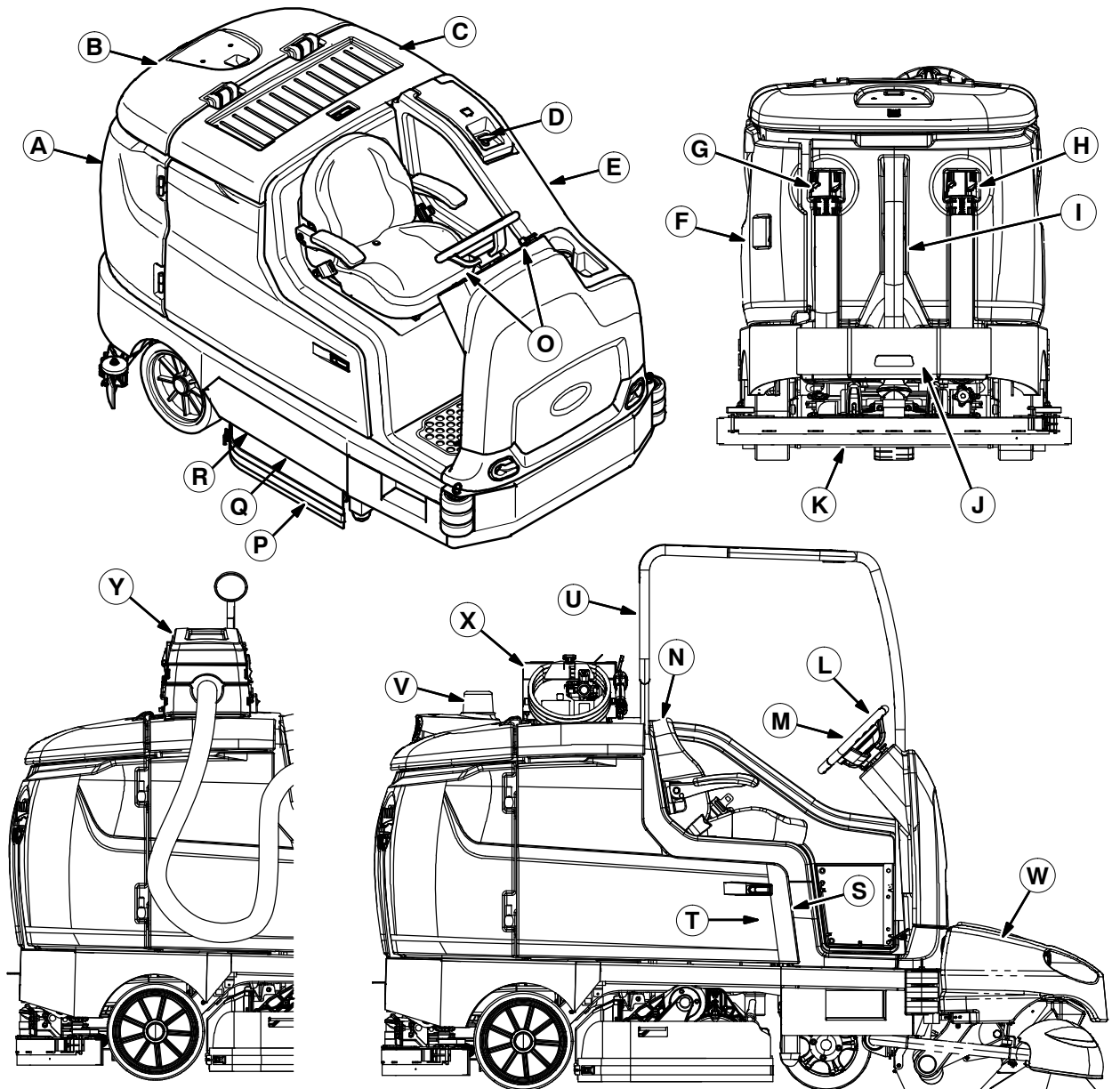

356408

- A. Recovery tank**
- B. Recovery tank cover**
- C. Battery compartment cover**
- D. Solution tank cover**
- E. Solution tank**
- F. Left shroud**
- G. Solution tank drain hose**
- H. Recovery tank drain hose**
- I. Vacuum hose**
- J. Rear squeegee**
- K. Rear bumper door / step**
- L. Steering wheel**
- M. Touch panel / Pro-Panel**
- N. Operator seat**
- O. Control / instrument panels**
- P. Side squeegee**
- Q. Scrub head**
- R. Main brush door**
- S. Right shroud**
- T. ec-H2O System Module
compartment (Option) – located behind
right shroud**
- U. Overhead guard**
- V. Backup alarm / flashing light (Option)**
- W. Pre-Sweep (Option)**
- X. High pressure washer (Option)**
- Y. Live wand dry vacuum (Option)**

OPERATION

CONTROLS AND INSTRUMENTS

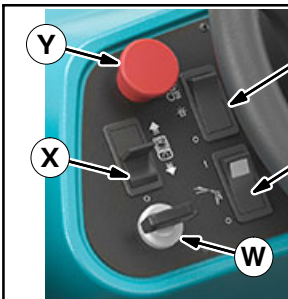
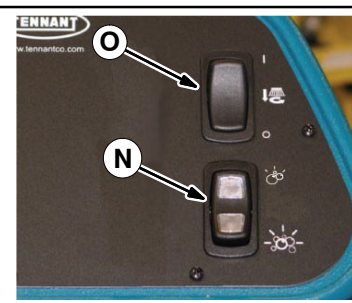
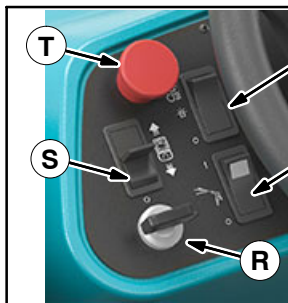
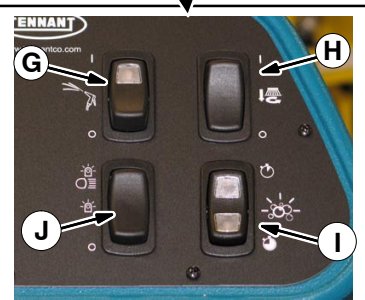
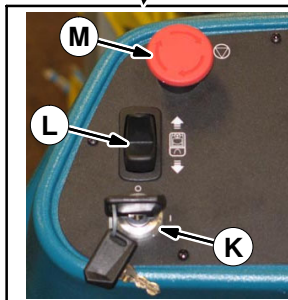

- A. Steering wheel
- B. Standard Touch panel
- C. Pro-panel
- D. Parking brake pedal
- E. Brake pedal
- F. Propel pedal

Standard Control Panel (S/N 0000–01199)

- G. Spray nozzle switch (option)
- H. Scrubbing side brush switch (option) / Sweeping side brush switch (option) / Pre-Sweep switch (option)
- I. Severe environment switch (option) or Detergent metering switch (option)
- J. Operating lights / hazard lights switch (option)
- K. Key switch
- L. Directional switch
- M. Emergency shut-off button

Standard Control Panel (S/N 01200–)

- N. Severe environment switch
- O. Pre-Sweep switch (option)
- P. Operating lights / hazard lights switch (option)
- Q. Spray nozzle switch (option) / High pressure washer switch (option)
- R. Key switch
- S. Directional switch
- T. Emergency shut-off button

Pro-Panel

- U. Operating lights / hazard lights switch (option)
- V. Spray nozzle switch (option) / High pressure washer switch (option)
- W. Key switch
- X. Directional switch
- Y. Emergency shut-off button

- A. Horn**
- B. Fault / Alert indicator light**
- C. Contrast control button**
- D. Battery discharge indicator**
- E. Hour meter**
- F. Solution tank indicator**
- G. Recovery tank full indicator**
- H. Configuration mode button**
- I. LCD display**
- J. Brush pressure button**
- K. Brush pressure indicator lights**
- L. 1-STEP button**
- M. ec-H₂O / ES (Extended Scrub / (Option)**
- N. Scrubbing main brush button**
- O. Scrubbing vacuum fan / squeegee button**
- P. Scrubbing side brush (Option)**
- Q. Solution on / off buttons**
- R. Solution flow decrease button (-)**
- S. Solution flow indicator lights**
- T. Solution flow increase button (+)**
- U. USB port (Service only)**

PRO-PANEL CONTROLS

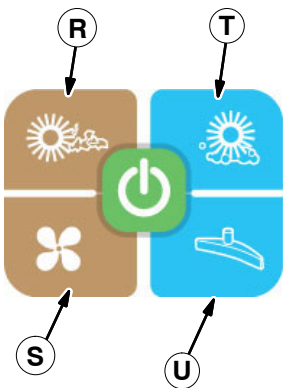
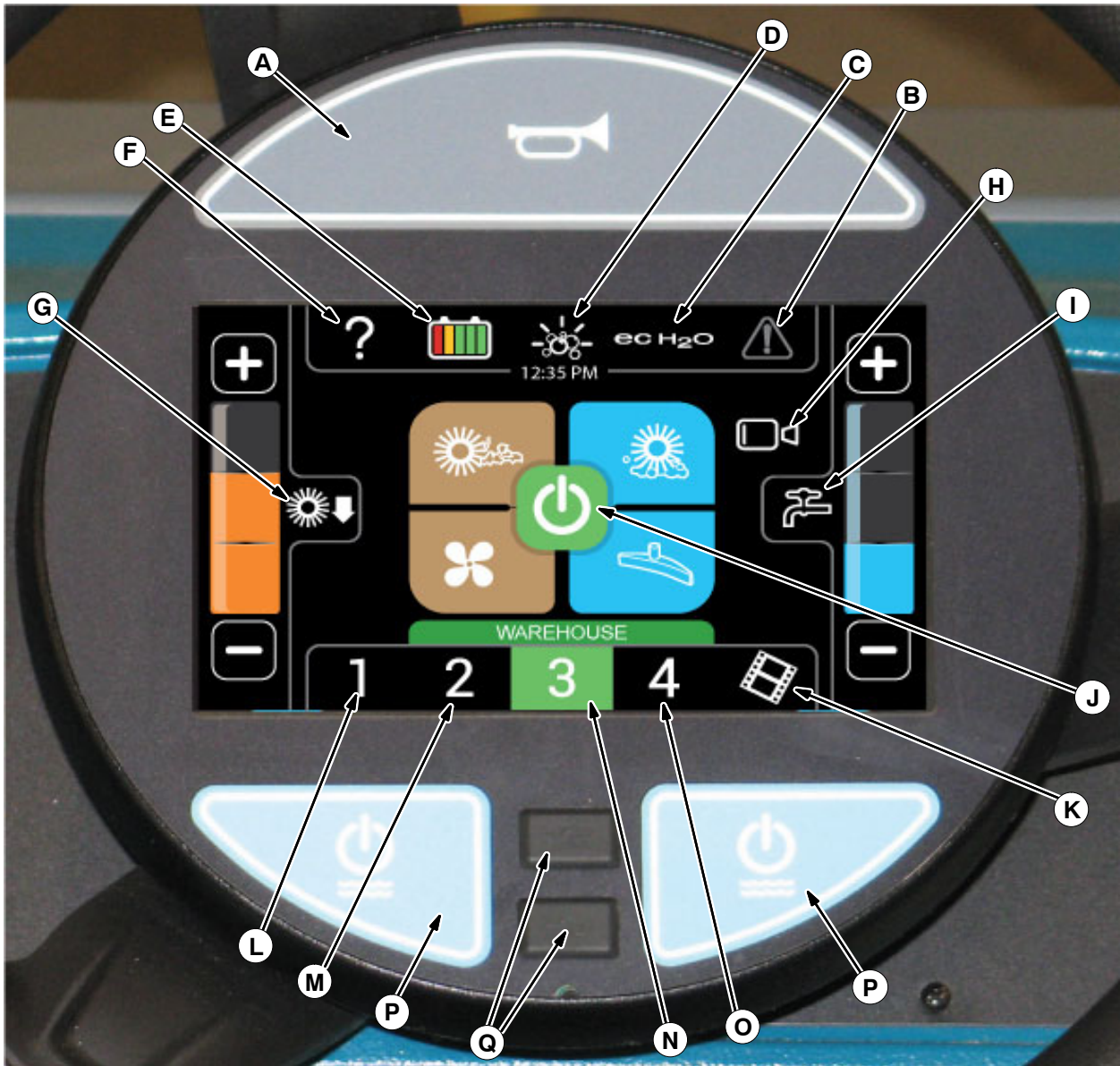

Scrubbing and pre-sweep



Scrubbing and sweeping side brush

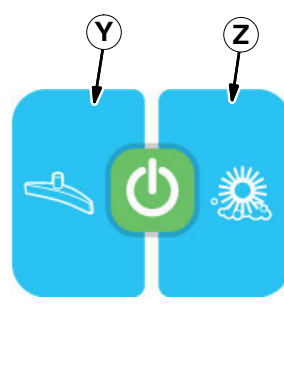

Scrubbing only

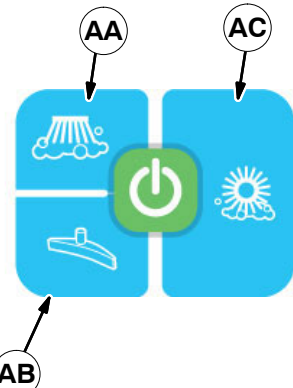

Scrubbing and scrubbing side brush

- A. Horn**
- B. Fault / Alert indicator light**
- C. ec-H2O / ES (Extended Scrub / (Option)**
- D. Severe environment button (Option) or Detergent metering button (Option)**
- E. Machine status button**
- F. Help button**
- G. Main brush pressure access button**
- H. Rearview camera button**
- I. Solution control access button**
- J. 1-STEP button**
- K. Video help**
- L. Zone control 1 button**
- M. Zone control 2 button**
- N. Zone control 3 button**
- O. Zone control 4 button**
- P. Solution on / off buttons**
- Q. USB ports (Service only)**

Scrubbing and pre-sweep (Option)

- R. Pre-sweep main brush button**
- S. Pre-sweep vacuum fan button**
- T. Scrubbing main brush button**
- U. Scrubbing vacuum fan / squeegee button**

Scrubbing and sweeping side brush (Option)

- V. Sweeping side brush button**
- W. Scrubbing main brush button**
- X. Scrubbing vacuum fan / squeegee button**

Scrubbing only



















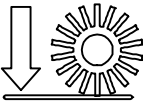









- Y. Scrubbing vacuum fan / squeegee button**
- Z. Scrubbing main brush button**

Scrubbing and scrubbing side brush (Option)

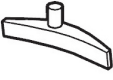
- AA. Scrubbing side brush button**
- AB. Scrubbing vacuum fan / squeegee button**
- AC. Scrubbing main brush button**

SYMBOL DEFINITIONS

These symbols are used on the machine to identify controls, displays, and features.

	Horn		Solution decrease (-)
	Fault / Alert indicator		Solution increase (+)
	Forward / Reverse		Solution flow
	Circuit breaker		Solution On / Off
	Main brush pressure		On
	1-STEP		Off
	ES (Extended Scrub) (Option)		Emergency shut-off
	Scrub mode		Spray nozzle (Option) / High pressure washer (Option)
ec H₂O	ec-H ₂ O (Option)		Severe environment (Option) or Detergent metering (Option)
	Operating lights / Hazard light		Hour meter
	Headlights		Scrubbing main brush
	Scrubbing side brush		Scrubbing vacuum fan / squeegee
	Battery charge		Emergency shut-off
	Contrast control		Jack point
	Configuration mode		

Standard Panel Symbols

Recovery tank



Contrast control



Solution tank



Configuration mode



Brush pressure (minimum / maximum)



















Solution flow (minimum / maximum)





















Side brush (option)

Pro-Panel Symbols

	Zone setting 1		Help
	Zone setting 2		Alert / Fault
	Zone setting 3		Enter
	Zone setting 4		Checklist item unconfirmed
	Hour meter		Checklist item confirmed
	Login		Logout
	Select		Supervisor settings
	Rotate machine view		Supervisor menu
	Camera settings		Start-up video
	Control help		Video help
	About		Video button
	Backspace		Video list button
	Rearview camera		Home (main operating screen)

Pro-Panel Symbols

	Up arrow		Down arrow
	Disable login		Back arrow
	Add / Edit profiles		Enable login
	Operator		Calibrate touch
	Supervisor		Checklist setup
	Edit profile		Export all
	Add profile		Export new
	Delete profile		Export checklists
	Copy profile		Screen lock
	Date / Time set		

OPERATION

OPERATION OF CONTROLS

BATTERY DISCHARGE INDICATOR

The *Battery discharge indicator* displays the charge level of the batteries while the machine is operating.



When the batteries are fully charged, all five bars are lit. Recharge the batteries when there is only one bar shown in the display. Do not allow the batteries to discharge below 20% (last bar).

NOTE: The reading on the battery discharge indicator is not accurate when the machine is first powered on. Operate the machine a few minutes before reading the charge level of the batteries.

NOTE: The flashing Warning / fault indicator and battery low fault in the LCD (liquid crystal display) will not reset until after the batteries have been fully charged. See FAULT INDICATOR(S).

HOUR METER

The *Hour meter* records the hours the machine was operated. Use this information to determine machine service intervals.



RECOVERY TANK FULL INDICATOR

The *Recovery tank full indicator* displays FULL when the recovery tank is full. All scrubbing functions will stop when the recovery tank is full. Empty the recovery tank when the indicator displays FULL.

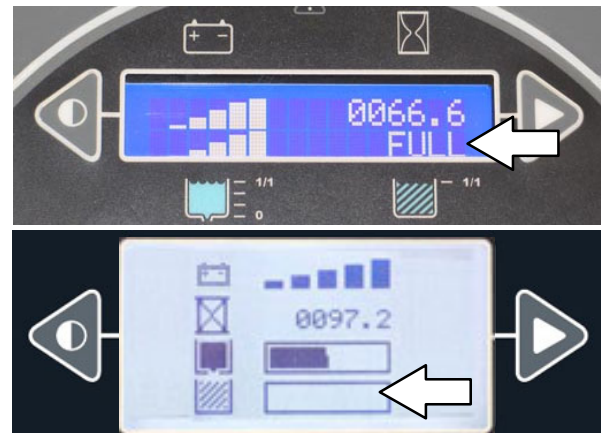

SOLUTION TANK INDICATOR

The *solution tank indicator* displays the amount of liquid in the solution tank. Refill the solution tank when there are no longer any bars shown in the display. The machine will stop scrubbing when the solution tank is empty.

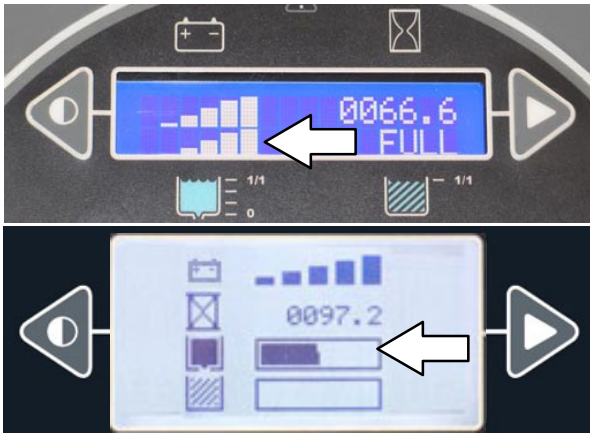

CONTRAST CONTROL BUTTON

Use the *Contrast control button* to darken / lighten the LCD display.



CONFIGURATION MODE BUTTON

The *Configuration mode button* is for accessing the configuration and diagnostic modes. Only properly trained service personnel and TENNANT representatives should access these modes.

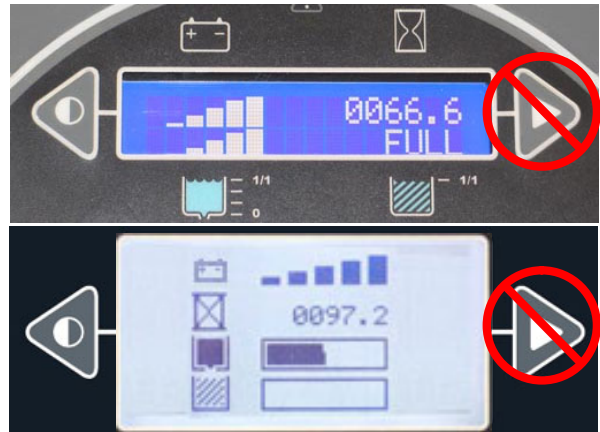

1-STEP BUTTON

Press the *1-STEP button* to activate all selected sweeping and scrubbing functions. Prior to the *1-STEP button* being pushed, the lights above all the selected sweeping / scrubbing functions will be on but the selected functions will be in the standby mode until the *1-STEP button* is pressed. Press the *1-STEP button* again when finished cleaning to stop all scrubbing and sweeping functions.

NOTE: The squeegee will remain down and the vacuum fan will remain on for a few seconds to pick up remaining water after the 1-STEP button is deactivated.

The indicator light above the button will illuminate when the 1-STEP button is activated.

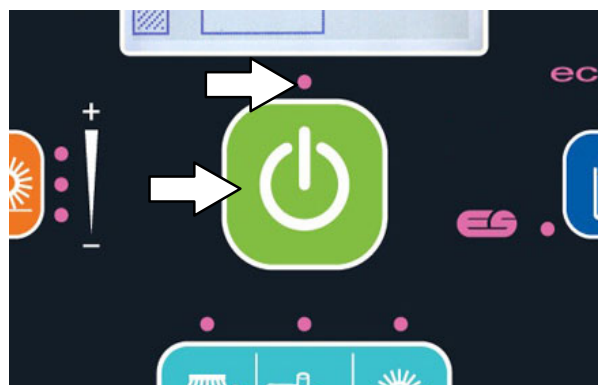

OPERATION

SIDE BRUSH BUTTON (OPTION)

The side brush button controls the sweeping or scrubbing side brush option.

Turn on the side brush: Press the *side brush button*. The indicator light will illuminate.

Turn off the side brush: Press the *side brush button*. The indicator light will turn off.

NOTE: The side brushes cannot operate independently from the main sweep brushes. The main sweep brushes also come on when the side brush button is pushed.

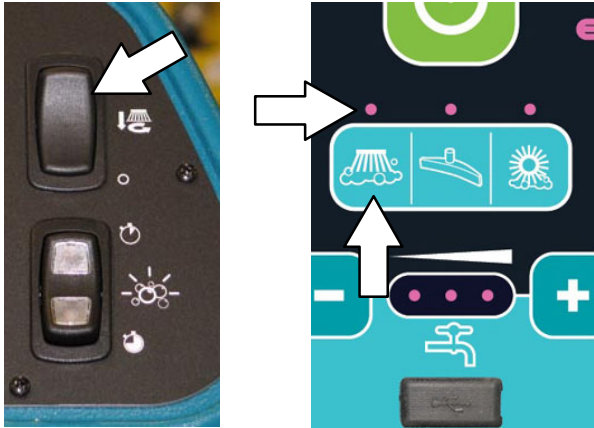

VACUUM FANS / SQUEEGEE BUTTON

Lower squeegee and turn vacuum fans on: Press the *Vacuum fans / squeegee button*. The indicator light will illuminate when the squeegee is lowered.

Raise squeegee and turn vacuum fans off: Press the *Vacuum fans / squeegee button*. The indicator light will go out when the squeegee is raised.

NOTE: The 1-STEP button does not need to be activated to operate the vacuum fans / squeegee system. The vacuum fans / squeegee button can be turned on or turned off with the 1-STEP button either on or off.

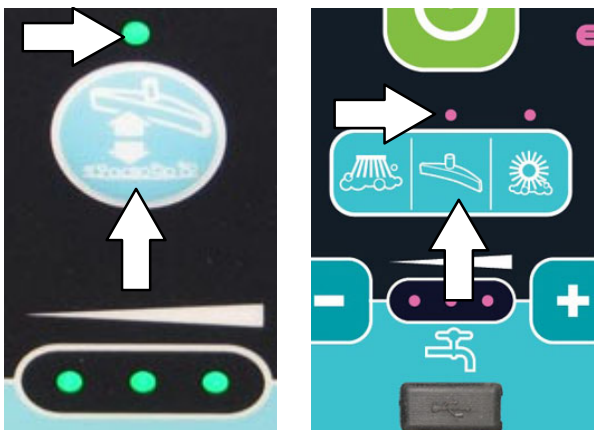

SCRUBBING MAIN BRUSH BUTTON

Turn on the scrubbing main brush: Press the *scrubbing main brush button*. The indicator light will illuminate.

Turn off the scrubbing main brush: Press the *scrubbing main brush button*. The indicator light will turn off.

NOTE: The scrubbing main brush will turn on for machines not equipped with the scrubbing main brush button when the 1-STEP button is pressed.

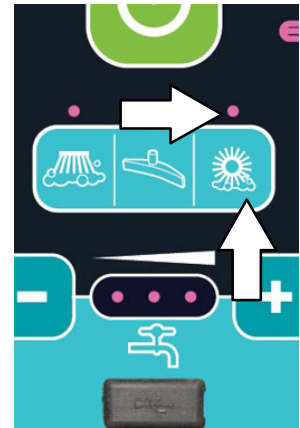

SOLUTION ON / OFF BUTTON

The solution flow is designed to stay on whenever the scrub brushes are on. It can be turned off for ten seconds with the *solution on / off button* to go around corners, etc. See also *SETTING THE SOLUTION FLOW* section.

Shut off the solution flow (for 10 seconds): Press the solution on / off button. All the solution flow indicators will turn off. (The solution flow will automatically restart at the end of the 10 second delay).

Turn on the solution flow: Press the *Solution on / off button* to turn on the solution flow. The solution indicator lights will turn back on and the solution flow will default to the last setting used.



SEVERE ENVIRONMENT SWITCH (OPTION)

The *Severe environment switch* provides a detergent boost for areas with extraordinary dirt or soil buildup.

Press the top of *Severe environment switch* to operate 30 seconds of detergent aided cleaning and the bottom to provide five minutes of detergent aided cleaning. The lights in the switch display which setting is activated.

NOTE: This switch can be configured to allow different flow times. Contact a Tennant service representative to change the default flow times.



The *ec-H2O* scrubbing mode is temporarily disabled when the severe environment switch is activated. The *ec-H2O* mode automatically comes back on when *Severe environment switch* is timed out / turned off.

The solution flow and brush pressure default to the highest / heaviest settings when the *Severe environment switch* is activated but can be adjusted to lower / lighter settings. See **SETTING BRUSH PRESSURE** section and **SETTING SOLUTION FLOW** section.

DETERGENT METERING (OPTION)

The Detergent Metering switch provides a continuous increased detergent flow for areas with extraordinary dirt or soil buildup.

Press the top of the switch to increase detergent flow. Press the bottom of the switch for even more increased detergent flow. The lights in the switch display which setting is activated.

NOTE: This switch can be configured to allow different flow rates. Contact a Tennant service representative to change the default flow rates.



OPERATION

PRE-SWEEP SWITCH (OPTION)

The Pre-sweep switch controls the pre-sweep and pre-sweep dust control options.

Press the top of the *Pre-Sweep switch* to start the Pre-Sweep *without* dust control. The top portion of the switch will illuminate.

Press the bottom of the *Pre-Sweep switch* to start the Pre-Sweep *with* dust control. The bottom portion of the switch will illuminate.

NOTE: *The Pre-Sweep assembly will begin sweeping and the dust control system will start operating when the machine propels forward.*

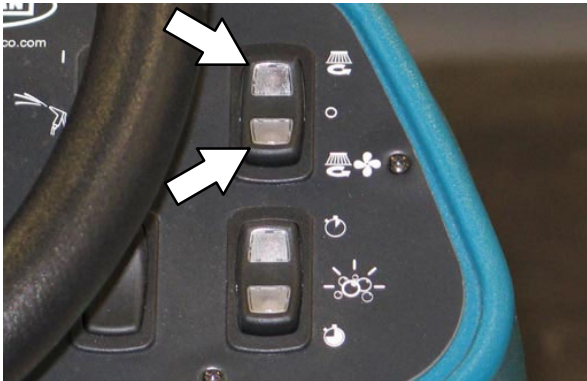

Press the illuminated portion (top or bottom) of the *Pre-Sweep switch* to shut off the Pre-sweep system and dust control system.

OPERATION OF CONTROLS – PRO-PANEL

PRO-ID LOGIN SCREEN

NOTE: The Pro-ID login screen only applies if the machine was set up with it. Predefined user accounts must be created within the Supervisor Mode.

Use the Pro-ID login screen to log into the machine.



Use the keypad to enter the user login number into the display above the keypad.



Press the Enter button to log into the machine.



Press the backspace button if necessary to delete and reenter a number.

When the Pro-Panel is in the Supervisor Mode, a gear symbol will appear in the lower right part of the screen. When it is in the Operator Mode, a video symbol will appear.

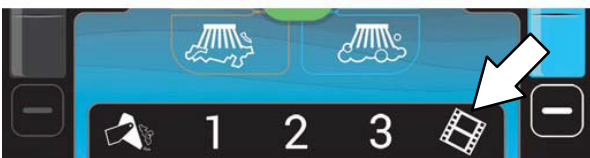
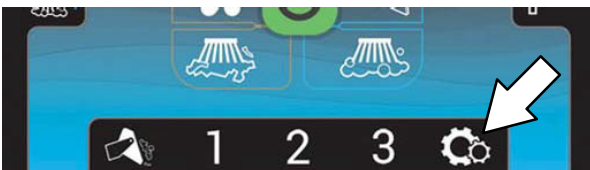

MACHINE STATUS BUTTON

The *machine status button* allows access to four different machine status indicators. The default display shows the battery status when the machine is turned on. Any of the four indicators can be set as the default display until the machine is turned off.

Press the *machine status button* to access all four machine status buttons. All four machine status buttons appear in the display for several seconds until the default buttons reappear in the display.

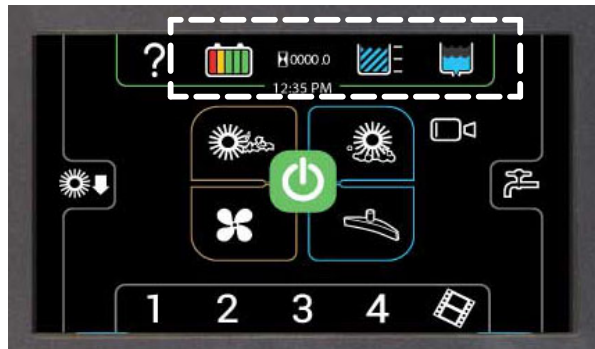
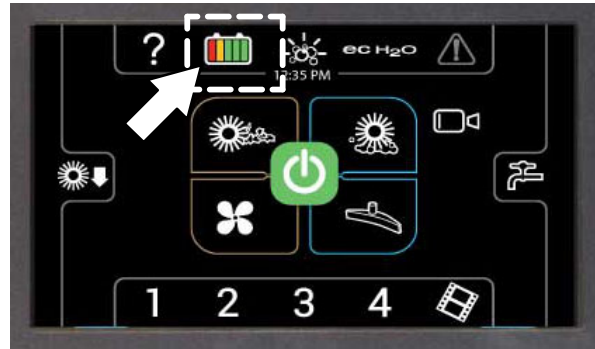



The *battery discharge indicator* displays the charge level of the batteries while the machine is operating.

When the batteries are fully charged, all five bars are illuminated. Recharge the batteries when there is only one bar shown in the display. Do not allow the batteries to discharge below 20% (last bar).

NOTE: The reading on the battery discharge indicator is not accurate when the machine is first powered on. Operate the machine a few minutes before reading the charge level of the batteries.

OPERATION

 The *hour meter* records the hours the machine was operated. Use this information to determine machine service intervals.

 The *solution tank indicator* displays the amount of liquid in the solution tank. Refill the solution tank when there are no longer any bars shown in the display. The machine will stop scrubbing when the solution tank is empty.

 The *recovery tank full indicator* displays FULL when the recovery tank is full. All scrubbing functions will stop when the recovery tank is full. Empty the recovery tank when the indicator displays FULL.

CHANGING THE DEFAULT BUTTON

Press the desired machine status button while all four machine status buttons appear in the display to change it to the new default button. The other three machine status buttons will disappear from the display and the newly selected machine status button will become the default until the machine is turned off. The battery status button will once again be the default when the machine is turned on.

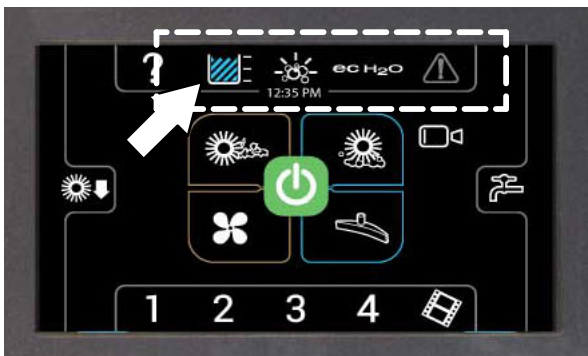
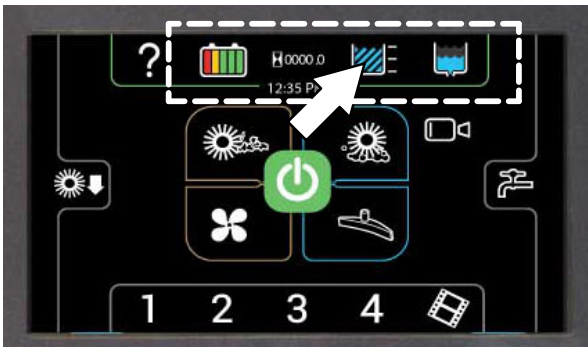

1-STEP BUTTON

Press the *1-STEP button* to activate all selected sweeping and scrubbing functions. Press the *1-STEP button* again when finished cleaning to stop all scrubbing and sweeping functions.

NOTE: The squeegee will remain down and the vacuum fan will remain on for a few seconds to pick up remaining water after the 1-STEP button is deactivated.

The *1-STEP button* and all selected scrubbing and sweeping function button will illuminate when the *1-STEP button* is pressed.

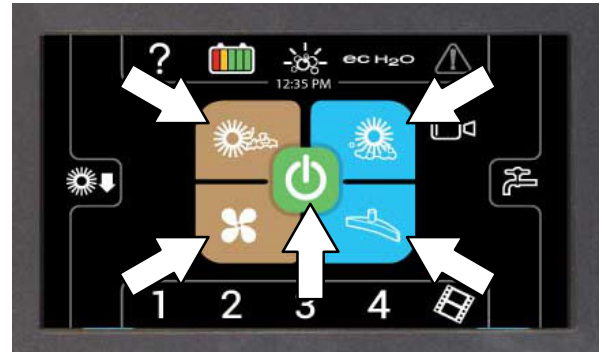

The edges of all selected sweeping and scrubbing buttons will be illuminated to show that they are in the standby mode prior to the *1-STEP button* being pressed. The selected buttons will become fully illuminated when the *1-Step button* is pressed.

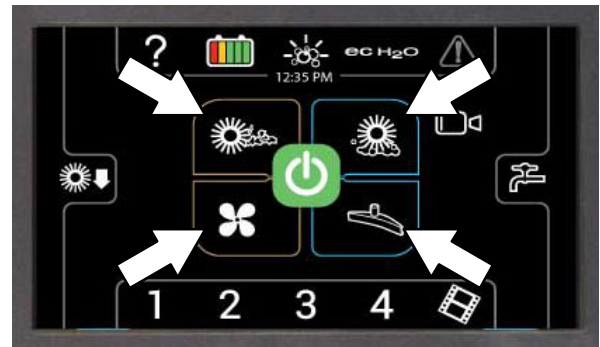

SCRUBBING MAIN BRUSH BUTTON

Turn on the scrubbing main brush: Press the *scrubbing main brush button*. The button will illuminate.

Turn off the scrubbing main brush: Press the *scrubbing main brush button*. The button will turn off.

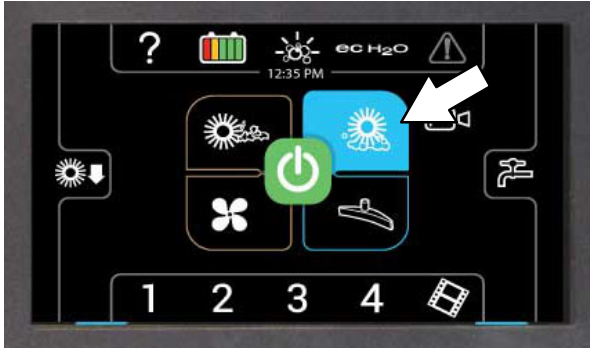

SCRUBBING SIDE BRUSH BUTTON (OPTION)

Turn on the scrubbing side brush: Press the *scrubbing side brush button*. The button will illuminate.

Turn off the scrubbing side brush: Press the *scrubbing side brush button*. The button will turn off.



SCRUBBING VACUUM FAN / SQUEEGEE BUTTON

Lower squeegee and turn vacuum fans on: Press the *scrubbing vacuum fan / squeegee button*. The button will illuminate.

Raise squeegee and turn vacuum fans off: Press the *vacuum fans / squeegee button*. The button will turn off.



SWEEPING SIDE BRUSH

Turn on the sweeping side brush: Press the *sweeping side brush button*. The button will illuminate.

Turn off the sweeping side brush: Press the *sweeping side brush button*. The button will turn off.



OPERATION

PRE-SWEEP BRUSH BUTTON

Turn on the pre-sweep brush: Press the pre-sweep brush button. The button will illuminate.

Turn off the pre-sweep brush: Press the pre-sweep brush button. The button will turn off.



PRE-SWEEP VACUUM FAN BUTTON

Turn on the pre-sweep vacuum fan: Press the pre-sweep vacuum fan button. The button will illuminate.

Turn off the pre-sweep vacuum fan: Press the pre-sweep vacuum fan button. The button will turn off.



SOLUTION ON / OFF BUTTON

The solution flow is designed to stay on whenever the scrub brushes are on. It can be turned off for ten seconds with the *solution on / off button* to go around corners, etc. See also *SETTING THE SOLUTION FLOW* section.

Shut off the solution flow (for ten seconds): Press the solution on / off button. All the solution flow indicators will turn off. (The solution flow will automatically restart at the end of the 10 second delay).

Turn on the solution flow: Press the *Solution on / off button* to turn on the solution flow. The solution indicator lights will turn back on and the solution flow will default to the last setting used.



SCREEN LOCK

The screen lock feature is designed to automatically lock the screen and prevent the accidental touching of machine control while operating the machine. The screen lock setting is adjusted in the Supervisors Controls. See *SETTING / CHANGING THE SCREEN LOCK* section.

Unlock the screen: Press the screen lock icon.

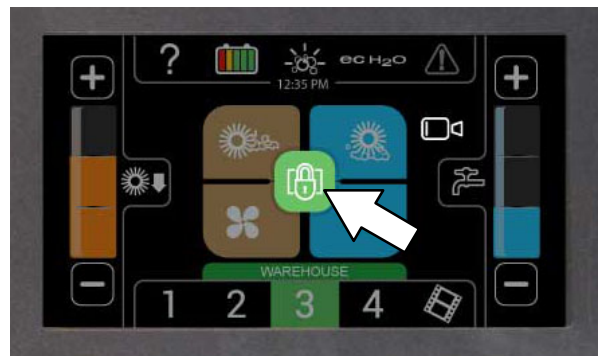

SEVERE ENVIRONMENT SWITCH (OPTION)

The *Severe environment button* provides a detergent boost for areas with extraordinary dirt or soil buildup.

Press the *Severe environment button* to operate 30 seconds of detergent aided cleaning. The severe environment button will illuminate when activated and will go out when timed out/ turned off. Press and hold the severe environment button several additional seconds to have the severe environment function activate five minutes of detergent aided cleaning.

NOTE: The Severe Environment switch can be configured to activate for longer than five minutes. Contact Tennant Service representative.



The amount of time remaining for the severe environment scrub is displayed in the middle of the *1-STEP button*. It will turn off automatically when the timer expires or when pressed again.

The *ec-H2O* scrubbing mode is temporarily disabled when the severe environment switch is activated. The *ec-H2O* mode automatically comes back on when *Severe environment switch* is timed out / turned off.

The solution flow and brush pressure default to the highest / heaviest settings when the *Severe environment switch* is activated but can be adjusted to lower / lighter settings. See *SETTING BRUSH PRESSURE* section and *SETTING SOLUTION FLOW* section.

DETERGENT METERING (OPTION)

The Detergent Metering switch provides a continuous increased detergent flow for areas with extraordinary dirt or soil buildup.



NOTE: This switch can be configured to allow different flow rates. Contact a Tennant service representative to change the default flow rates.

Press the Detergent Metering Button to change the detergent flow rate. The button will toggle through the 3 different settings.

	off
	low (1% detergent flow)
	High (3% detergent flow)

OPERATION

ZONE CONTROL BUTTONS

Machines equipped with the Pro-Panel can be pre-programmed for up to four preset scrubbing / sweeping settings for different floor cleaning applications. These must be set up ahead of time using the supervisor mode. See *PROGRAMMING THE ZONE CONTROL BUTTONS* section.

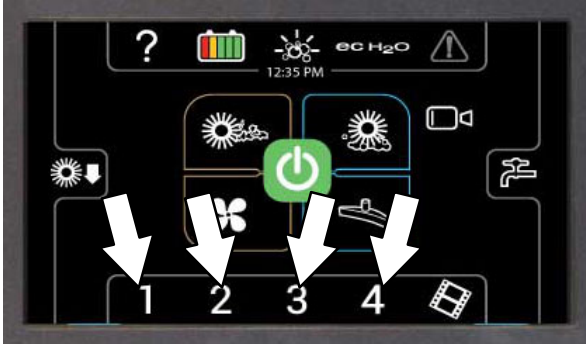

Press the required zone control button. The selected preset button will illuminate and the name of the zone appears above the button. The *solution flow indicator bar / adjustment buttons* and *brush pressure indicator bar / adjustment buttons* briefly appear in the display to show the settings for the selected zone.



REARVIEW CAMERA BUTTON

Press the *rearview camera button* to check cleaning performance. The rearview camera screen will appear in the control panel display for a short amount of time. The main operating screen returns to the control panel after the rearview camera times out. Touch anywhere on the control panel display to turn off the rearview camera and return to the main operating screen.

FOR SAFETY: When using machine, always be aware of your surroundings.



The camera automatically comes on when the *directional switch* is placed in the reverse position and remains on the entire time the machine is in reverse.

The rearview camera is located on the recovery tank, above where the vacuum hose is attached to the recovery tank.



HELP BUTTON

FOR SAFETY: When using machine, do not access the video / help screens while the machine is moving (Pro-Panel).

Press the *help button* to access the help screen.





Press the applicable button for the help topic needed.





 Press the *select language button* to go to the language screen.

 Press the *login / logout button* to log in / log out of the machine operating system.

 Press the *controls help button* to access the controls help screen.

 Press the *start-up video button* to watch the start-up video.

 Press the *about button* to access machine operating system information.

 Press the *Pre-Operation Checklist button* to access the Pre-Operation Checklist.

OPERATION

Press the select language button. Select an applicable language from the list to change the machine operating system language. A flag designating the country language selected will appear at the top of the screen.



 Press the *down arrow button* to scroll down through the language list.

 Press the *up arrow button* to scroll up through the language list.

 Press the *back arrow button* to return to the previous screen.

 Press the *Pre-Operation Checklist button* to access the Pre-Operation Checklist.

Press the *control help button* to access information about the Pro-Panel controls.





 Press the *back arrow button* to return to the main help screen.

 Press the *home button* to return to the main operating screen.

Press the *about button* to access information about the operating system software.



 Press the *down arrow button* to scroll down through the language list.

 Press the *up arrow button* to scroll up through the language list.

 Press the *home button* to return to the main operating screen.

 Press the *back arrow button* to return to the previous screen.

 Press the *forward arrow button* to access machine information from the list.

VIDEO HELP BUTTON

FOR SAFETY: When using machine, do not access the video / help screens while the machine is moving (Pro-Panel).

*NOTE: Stop machine before accessing video help screen / videos. **Do Not** access the video help screen / videos while the machine is moving.*

Press the *video button* to access the video help screen.



 Press the applicable *video button* to view the help video for a particular machine component.

 Press the *rotate machine button* to access video help buttons located on the front, back, or other side of the machine.

 Press the *home button* to return to the main operating screen.

 Press the *back arrow button* to return to the previous screen.

 Press the *video list button* to access a text list of all help videos.

Select an applicable video from the list to view the video if the *video list button* was pressed to access the video list.

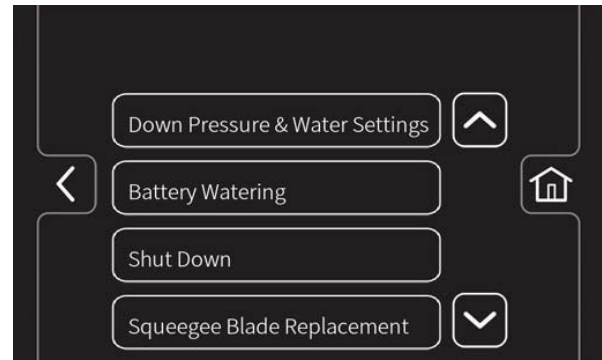

 Press the *down arrow button* to scroll down through the language list.

 Press the *up arrow button* to scroll up through the language list.

 Press the *home button* to return to the main operating screen.

 Press the *back arrow button* to return to the previous screen.

OPERATION

COMPLETING THE PRO-CHECK PRE-OPERATION CHECKLIST

Machines equipped with the Pro-Panel controls can be pre-programmed with the Pro-Check Pre-Operation Checklist the operator must complete before operating the machine.

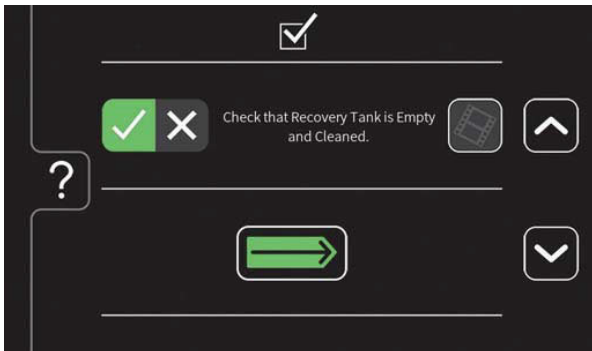

Press the *down arrow button* to scroll down through the language list.



Press the *up arrow button* to scroll up through the language list.



Press the *complete (check mark) button* to confirm the checklist item was checked. Press the *problem found (X) button* if a problem is found when checklist item is checked.



Press the *video help button* to view the video related to a particular checklist item.



Press the *enter button* when ready to start using the machine after completing the checklist.



Press the *help button* to access the Pro-Check Pre-Operation Checklist help screen.

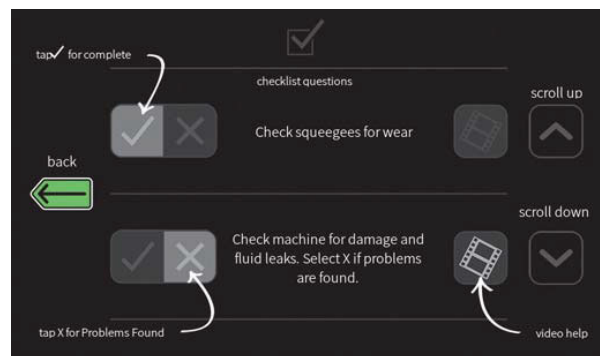

Press the *back arrow button* to return to the main help screen.

The operator is not allowed to access the main operating screen / use machine until the Pro-Check Pre-Operation Checklist is completed. Press the *back arrow button* to return to the checklist screen.

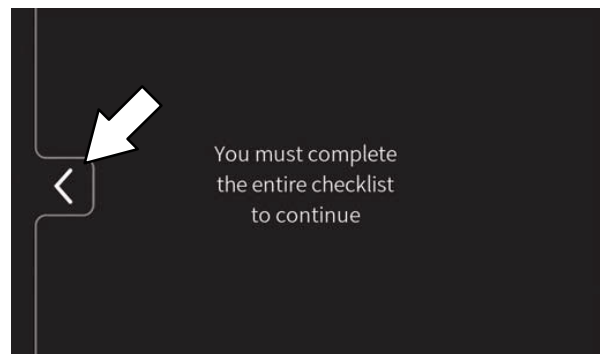

OPERATION OF CONTROLS – ALL MACHINES

EMERGENCY SHUT-OFF BUTTON

The *Emergency shut-off button* immediately stops the machine.

Stop machine power: Push the *Emergency shut-off button*.

Restart machine power: Turn the *Emergency shut-off button* to the right to release the button. Turn the key switch to the OFF position, then turn the key fully clockwise and release it to the ON position.



Only use this button in the event of an emergency. It is not intended for routine machine shutdown.

DIRECTIONAL SWITCH

Use the *Directional switch* to select either the forward or reverse direction. Press the propel pedal to move the machine.



NOTE: An audible alarm will sound when the Directional switch is placed into reverse.

NOTE: Machines equipped with the optional flashing light / backup alarm only: The optional backup light and alarm will function only when the machine is moving in reverse.

OPERATING / HAZARD LIGHT SWITCH (OPTION)

Operating and Hazard Lights On: Press the top of the *Operating / hazard light switch*.

Hazard Lights On: Press the *Operating / hazard light switch* to the middle position.

All Lights Off: Press the bottom of the *Operating / hazard light switch*.

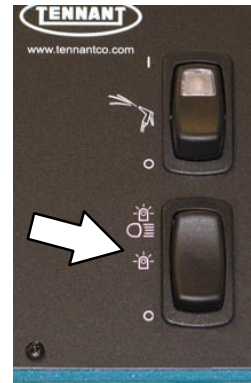

OPERATION

PROPEL PEDAL

Press the *Propel pedal* to move the machine.



OPERATOR SEAT

The front-to-back adjustment lever adjusts the seat position.



BRAKE PEDAL

Press the *Brake pedal* to stop the machine.



SEAT BELTS (Deluxe Seat Option Only)

FOR SAFETY: Before starting machine, adjust seat and fasten seat belt.



PARKING BRAKE PEDAL

Position toe onto the *Parking brake pedal* and press both the *Brake pedal* and *Parking brake pedal* down to engage the parking brake. Press just the *Brake pedal* to release the parking brake.



REAR BUMPER DOOR / STEP

The *Rear bumper door / step* provides easier access to the top of the machine for cleaning the recovery tank and can be lowered to access the lower rear areas of the machine near the rear squeegee and the squeegee vacuum hose.

The *Rear bumper door / step* must also be lowered to completely empty both the solution tank and the recovery tank.

To open the *Rear bumper door / step*, lift the *Rear bumper door / step* with the handle and place into the lowered position.

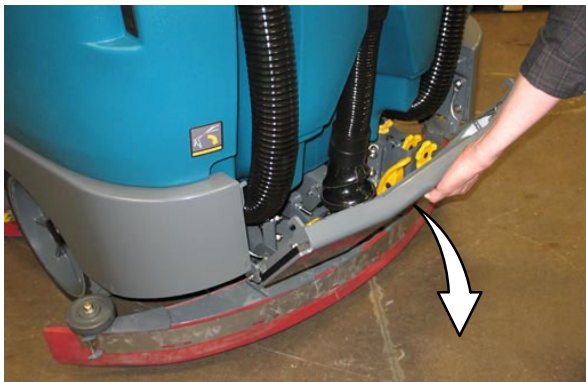
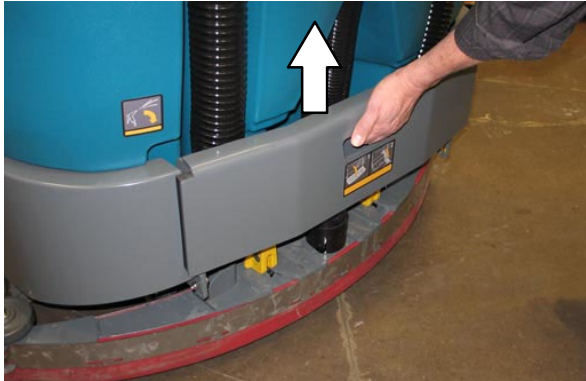

To close the *Rear bumper door / step*, lift it with the handle and lock it into the raised position.



FOR SAFETY: Do not operate machine with the rear bumper door / step in the lowered position. Do not carry passengers on any part of the machine.



NOTE: Step only in the tread area of the *Rear bumper door / step*. **Do Not** step into the two marked indented non-tread areas on each side of the *Rear bumper door / step*.



HOW THE MACHINE WORKS

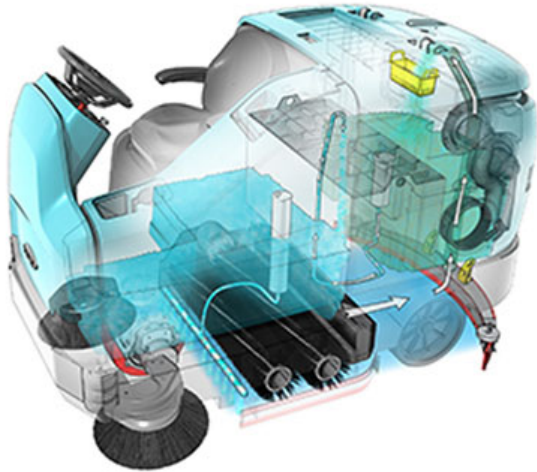

T17 With Cylindrical Brushes

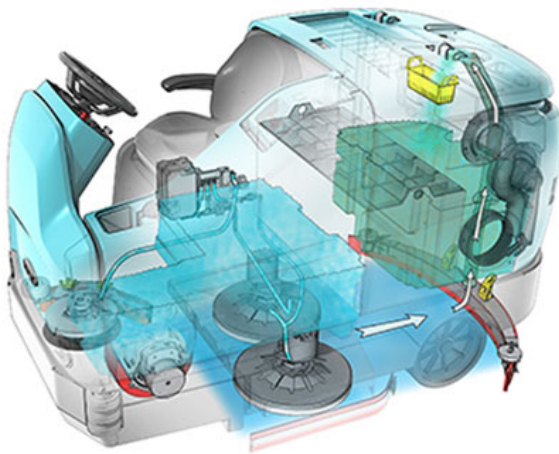

T17 With Disk Brushes

The *1-STEP button* makes it possible to immediately begin scrubbing by operating all the scrubbing functions.

When in the conventional scrub mode, a water and detergent mixture is used to scrub the floor.

When in the optional ES (Extended Scrub) mode, the dirty solution in the recovery tank is filtered through the ES system and returned to the solution tank for reuse. Detergent is then injected into the returned solution to revitalize the cleaning capability of the solution.

When in the optional *ec-H₂O* (electrically converted water) mode, normal water passes through a module where it is oxygenated and charged with an electric current. The electrically converted water changes into a blended acidic and alkaline solution forming a neutral pH cleaner. The converted water attacks the dirt, breaks it into smaller particles, and pulls it off the floor surface allowing the machine to easily scrub away the suspended soil. The converted water then returns to normal water in the recovery tank. The *ec-H₂O* system can be used with all double scrubbing and heavy duty scrubbing applications.

BRUSH AND PAD INFORMATION

For best results, use the appropriate brush or pad for the cleaning application. Listed below are brushes and pads and the applications for which each is best suited.

NOTE: The amount and type of soilage play an important role in determining the type of brush or pad to use. Contact a Tennant representative for specific recommendations.

Nylon brush (Cylindrical and Disk)* – Softer nylon bristles are recommended for scrubbing coated floors. Cleans without scuffing.

Heavy Duty Polypropylene brush (Disk) – Heavy duty polypropylene bristles provide a more aggressive cleaning performance and can more easily lift compacted dirt, debris, and sand while offering excellent scrubbing performance.

Polypropylene brush (Cylindrical and Disk)* – General purpose polypropylene bristles lift lightly compacted dirt without scuffing high-gloss coated floors.

Super AB brush (Cylindrical and Disk)* – Nylon fiber with an abrasive grit to remove stains and compacted dirt. Aggressive action on any surface. Performs well on buildup, grease, or tire marks.

* This brush is also available for the side brush.

Stripping pad (Brown) – For stripping of floor finish to prepare the floor for recoating.

Scrubbing pad (Blue) – For medium to heavy-duty scrubbing. Removes dirt, spills, and scuffs.

Buffing pad (Red) – For light duty scrubbing without removing floor finish.

Polishing pad (White) – For maintaining highly polished or burnished floors.

High productivity stripping pad (Black) – For aggressive stripping of heavy finishes or sealers, or for very heavy duty scrubbing. *This pad can only be used with the grip pad driver, not the tufted pad driver.*

Surface preparation pad (Maroon) – For very aggressive chemical free removal of floor finish to prepare the floor for re-coating

Grip pad driver – The grip-face backing allows pads to be fully used and holds pads in place without penetrating the pad. The spring-activated centering device works with all Tennant pads and allows for fast, easy pad replacement.

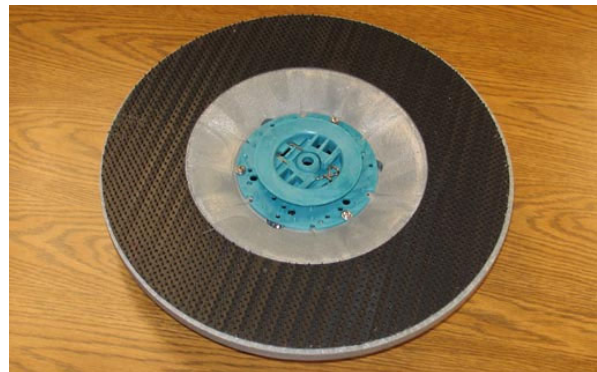

Tufted pad driver – Standard pad driver has short bristles, or “tufts,” on the back to hold the pad in place. This driver works with all Tennant pads except the black high productivity pad.



WHILE OPERATING THE MACHINE

Pick up oversized debris before scrubbing. Pick up wire, string, twine, large pieces of wood, or any other debris that could become wrapped around or tangled in the brushes.

Drive in a straight a path as possible. Avoid bumping into posts or scraping the sides of the machine. Overlap the scrub paths by several centimeters (a few inches).

Avoid turning the steering wheel too sharply when the machine is in motion. The machine is very responsive to the movement of the steering wheel. Avoid sudden turns, except in emergencies.

Adjust the machine speed, brush pressure, and solution flow as required when scrubbing. Use the lowest brush pressure and solution flow settings for best performance.

If poor cleaning performance is observed, stop cleaning and refer to *MACHINE TROUBLESHOOTING* in this manual.

Perform the Daily Maintenance Procedures after each use (see *MACHINE MAINTENANCE* in this manual).

Drive the machine slowly on inclines. Use the brake pedal to control machine speed on descending inclines. Scrub with the machine up inclines rather than down inclines.

FOR SAFETY: When using machine, go slowly on inclines and slippery surfaces.

Do not operate machine in areas where the ambient temperature is above 43° C (110° F). Do not operate scrubbing functions in areas where the ambient temperature is below freezing 0° C (32° F).

FOR SAFETY: When using machine, do not scrub on ramp inclines that exceed 8.7% grade or transport (GVWR) on ramp inclines that exceed 12% grade.

PRE-OPERATION CHECKLIST

Perform the following steps before operating the machine:

- Check the machine for fluid leaks.
- Check left side squeegee for wear and damage.
- Check main brushes for wear and damage. Remove wire, string, or twine wrapped around the main scrub brushes.
- Machines equipped with cylindrical brushes: Confirm the debris tray is empty and clean.
- Machines equipped with side brush option: Check for wire, string, or twine wrapped around the scrub brush.
- Machines equipped with side brush option: Check squeegee for wear and damage.
- Machines equipped with Pre-Sweep option: Check for wire, string, or twine wrapped around the scrub brush.
- Machines equipped with Pre-Sweep option: Check dust control filter bag.
- Machines equipped with Pre-Sweep option: Confirm debris trough is empty.
- Machines equipped with live wand option: Confirm debris tray is empty.
- Check the rear squeegees for wear and damage.
- Check the recovery tank cover seal for wear or damage.
- Confirm the vacuum fan inlet filter is clean.
- Machines equipped with ES option: Ensure ES filter at bottom of recovery tank is clean.
- Check the right side squeegee for wear and damage.
- Check the solution tank cover seal for wear or damage.
- ec-H2O* Scrubbing: Confirm all conventional cleaning agents/restorers are drained and rinsed from the solution tank.
- ec-H2O* Scrubbing: Confirm the solution tank is filled with **clear cool water only**.
- Check the horn, headlights, taillights, safety lights, and backup alarm (if equipped).
- Check the brakes and steering for proper operation.
- Check the parking brake pedal for proper operation.
- Check the tires for damage.
- Check maintenance records to determine maintenance requirements.

OPERATION

STARTING THE MACHINE

FOR SAFETY: Before starting machine, adjust seat and fasten seat belt (if equipped).

1. Sit in the operators seat.
2. Turn the *Key switch* to the ON position.

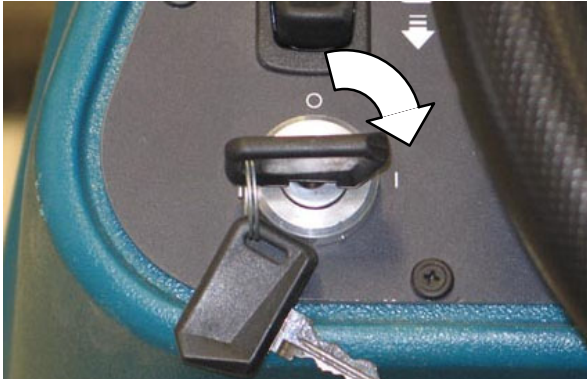

3. Turn on lights (if equipped).
4. Place the *Directional switch* into the direction needed to travel.
5. Press the *Propel pedal* to move the machine.

NOTE: The machine will not travel unless the operator is sitting in the operator seat.

FILLING THE DETERGENT TANK (OPTION)

FOR SAFETY: Before leaving or servicing machine, stop on level surface, turn off machine, set parking brake, and remove key.

1. Open the left shroud to access the detergent tank.
2. Remove the cap from the detergent tank.



3. Pour detergent into the detergent tank.



4. Reinstall the cap onto the detergent tank.

FILLING THE SOLUTION TANK

CONVENTIONAL SCRUBBING MODE

FOR SAFETY: Before leaving or servicing machine, stop on level surface, turn off machine, set parking brake, and remove key.

1. Twist the handle and lift the solution tank cover open.



2. Partially fill solution tank with water (not to exceed 60°C / 140°F). Pour the required amount of detergent into the solution tank. Continue filling the solution tank with water until the level is approximately 25 mm (1 in) below the opening.

WARNING: Flammable materials can cause an explosion or fire. Do not use flammable materials in tank(s).

ATTENTION: For Conventional Scrubbing, only use recommended cleaning detergents. Machine damage due to improper detergent usage will void the manufacturer warranty.

NOTE: Pour a recommended foam control solution into the recovery tank if excessive foam appears. For specific detergent recommendations, contact a Tennant representative.

3. Close the solution tank cover.

ec-H₂O SCRUBBING (ec-H₂O MODE)

FOR SAFETY: Before leaving or servicing machine, stop on level surface, turn off machine, set parking brake, and remove key.

1. Twist the handle and lift the solution tank cover open.



2. Fill the solution tank with only clean COOL WATER (less than 21°C / 70°F). DO NOT use hot water or add any conventional floor cleaning detergents or an ec-H₂O system failure may result. Fill the solution tank with water until the level is approximately 25 mm (1 in) below the opening.

WARNING: Flammable materials can cause an explosion or fire. Do not use flammable materials in tank(s).

NOTE: Do not use the ec-H₂O system when there are conventional cleaning detergents in the solution tank. Drain, rinse, and refill the solution tank with clear cool water before operating the ec-H₂O system. Conventional cleaning detergents may cause an ec-H₂O system failure.

3. Close the solution tank cover.

OPERATION

ES (EXTENDED SCRUB) MODE – MANUAL TANK FILL

FOR SAFETY: Before leaving or servicing machine, stop on level surface, turn off machine, set parking brake, and remove key.

1. Open the solution tank cover.



2. Fill solution tank with water (not to exceed 60°C / 140°F). Fill the solution tank with water until the level is approximately 25 mm (1 in) below the opening.
3. Close the solution tank cover.



4. Fill the recovery tank to just above the top of the ES filter with water (not to exceed 60°C / 140°F).



5. Close the recovery tank cover.
6. Fill the detergent tank with detergent.

WARNING: Flammable materials can cause an explosion or fire. Do not use flammable materials in tank(s).

AUTO-FILL (OPTION)

FOR SAFETY: Before leaving or servicing machine, stop on level surface, set parking brake, and turn off machine.

1. Lower the *Rear bumper door / step*.
2. Connect the hose from the water source (not to exceed 60°C / 140°F) to the auto-fill connection.

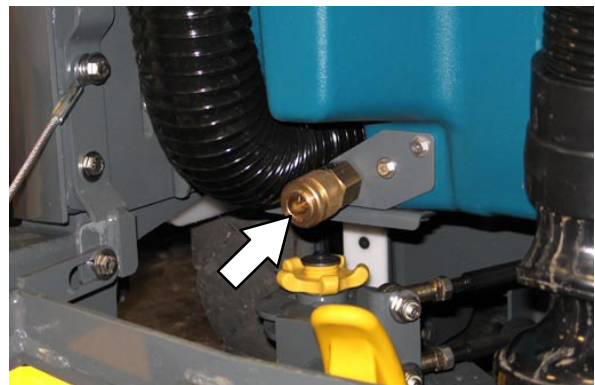

3. Turn the *Key switch* to the on position and turn on the water source. The auto-fill automatically fills the tank(s) to the proper level(s).

WARNING: Flammable materials can cause an explosion or fire. Do not use flammable materials in tank(s).

ATTENTION: For ES Scrubbing, only use recommended low-foaming cleaning detergents. Machine damage due to the use of improper detergent will void the manufacturer's warranty.

4. Raise the *Rear bumper door / step*.

ec-H2O BUTTON (OPTION)

The *ec-H2O button* enables the *ec-H2O system* to come on when the *1-STEP button* is activated. Press the *ec-H2O button* to turn on the *ec-H2O system*.

ec-H2O machines equipped with severe environment switch only: Machines equipped with the *severe environment switch* default to the *ec-H2O setting* upon start up.

Machines equipped with standard control panel: The *ec-H2O button* enables the *ec-H2O system* to come on when the *1-STEP button* is activated. The light above the button will come on.

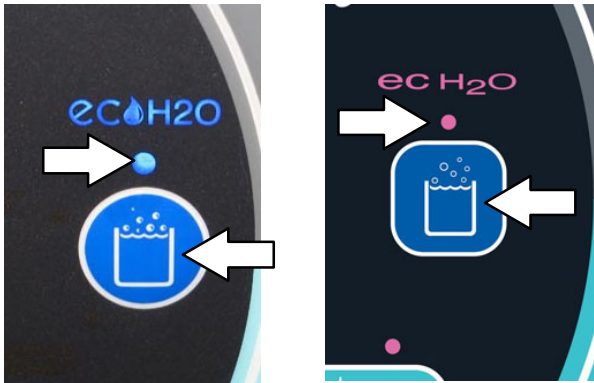

Standard Panel

A flashing red light located on the bottom portion of the LED (light-emitting diode) light directly above the *ec-H2O button* indicates when the *ec-H2O system* needs to be flushed. See *ec-H2O MODULE FLUSH PROCEDURE* in the *MAINTENANCE* section.



Standard Panel

Machines equipped with Pro-Panel controls:

The background will change from black to the multicolored background, the slash disappears from the *ec-H2O button*, and the button is illuminated when the *ec-H2O button* is pushed to indicate it is active.

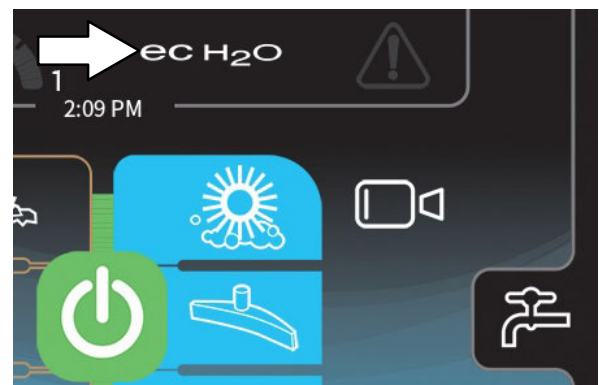
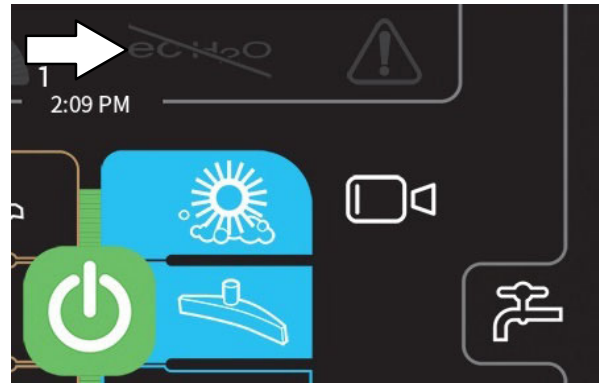

Pro-Panel

The *ec-H2O button* will turn red, the fault / alert indicator button will flash, and an *ec-H2O error message* will appear in the display when there is an *ec-H2O error*.



Pro-Panel

ES (EXTENDED SCRUB) BUTTON (OPTION)

The *ES button* enables the *ES system* to come on when the *1-STEP button* is activated.

Machines equipped with standard control panel: The *ES button* enables the *ES system* to come on when the *1-STEP button* is activated. The light next to the button will come on.

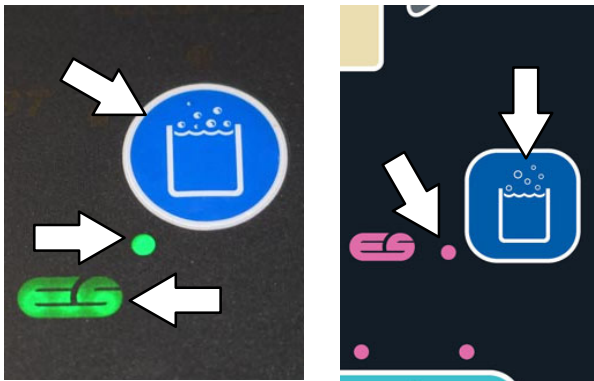

Standard Panel

Machines equipped with Pro-Panel controls: The slash disappears from the *ES button* and the button is illuminated when the *ES button* is pushed to indicate it is active.

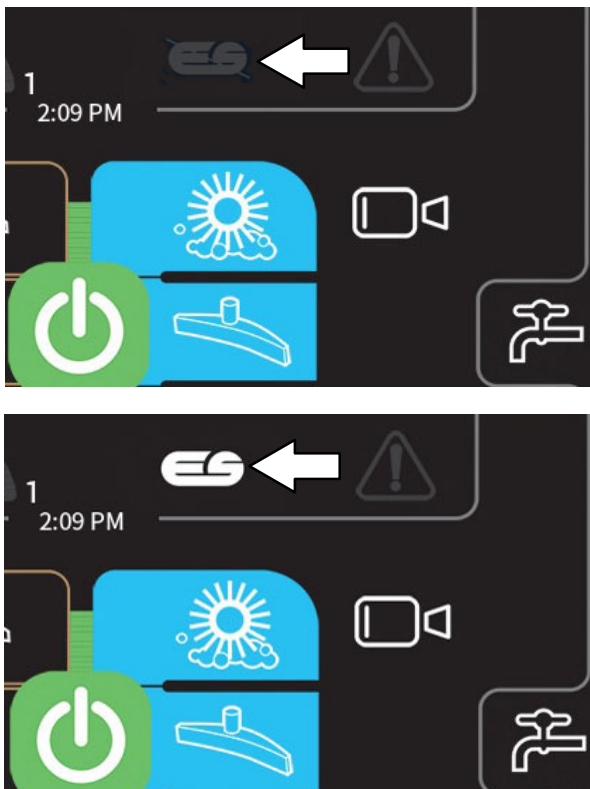

Pro-Panel

SCRUB BRUSH PRESSURE

Under normal cleaning conditions, the brush pressure should be set to the lowest setting. Under heavy grime conditions, the brush pressure can be set to a higher setting. Travel speed and floor conditions will affect cleaning performance. If brushes are worn, it may be necessary to increase the brush pressure. The machine will default to the last setting used when it is powered on or off.

SETTING SCRUB BRUSH PRESSURE – STANDARD PANEL

With the 1-STEP button activated, press the brush pressure button to both raise or lower the brush pressure settings. The brush pressure indicator lights display the current brush pressure setting.

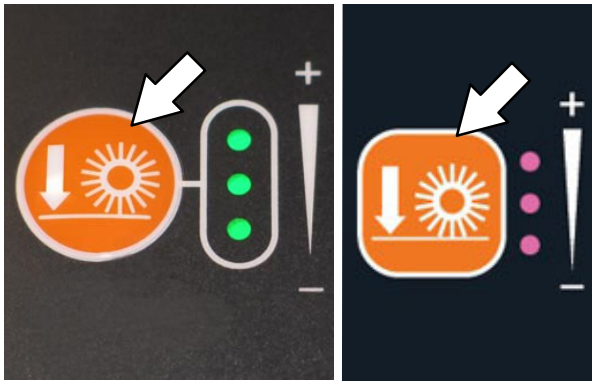

SETTING SCRUB BRUSH PRESSURE – PRO-PANEL

Press the brush pressure button to access the brush pressure increase (+) button, the brush pressure decrease (-) button, and the brush pressure indicator bar.

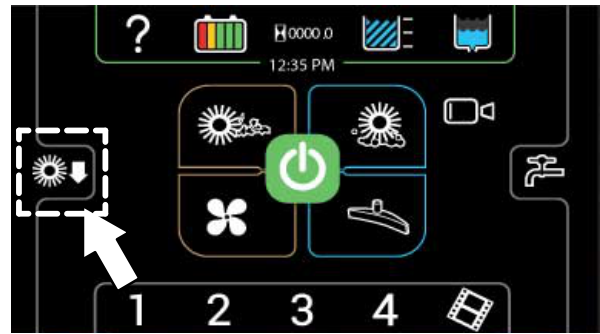

Use the brush pressure increase (+) button and the brush pressure decrease (-) button to change the brush pressure. The brush pressure indicator bar displays the current brush pressure setting.

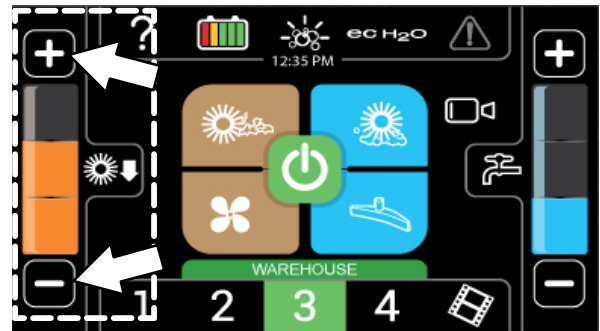

OPERATION

SOLUTION FLOW

Travel speed and floor conditions will affect scrubbing performance. Under normal soilage conditions the solution flow level should be set to the lowest setting (the left light). Under heavy grime conditions, the solution flow level should be set to the higher settings (middle or right lights). The machine will default to the last setting used when the machine is powered on or off.

SETTING SOLUTION FLOW – STANDARD PANEL

With the *1-STEP* button activated, press either *Solution increase button (+)* or *Solution decrease button (-)* to set the solution flow level. The solution flow indicator lights display the current solution flow setting.

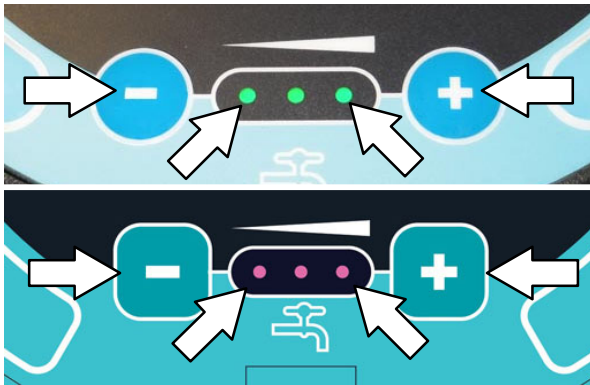

SETTING SOLUTION FLOW – PRO-PANEL

Press the *solution flow button* to access the *solution increase (+) button*, the *solution decrease (-) button*, and the *solution flow indicator bar*.



Use the *solution increase (+) button* and the *solution decrease (-) button* to set the solution flow level. The *solution flow indicator bar* displays the current solution flow setting.



SCRUBBING – STANDARD PANEL

FOR SAFETY: Do not operate machine, unless operator manual is read and understood.

1. Turn on the machine.
2. Press the *1-STEP* button. The light near the button will come on.



3. If necessary, activate the scrub mode required for the area to be cleaned.
4. If necessary, adjust the brush pressure and solution flow.
5. Place the *Directional switch* in the forward position.
6. Press the *Propel pedal* to begin scrubbing.

NOTE: DO NOT turn on the ec-H2O system during conventional scrubbing. Conventional cleaning detergents could cause an ec-H2O system failure. Drain, rinse, and refill the solution tank with cool clean water before operating the ec-H2O system.

ec-H2O machines only: A flashing red light located on the bottom portion of the LED (light-emitting diode) light directly above the ec-H2O button indicates when the ec-H2O system needs to be flushed. See ec-H2O *MODULE FLUSH PROCEDURE* in the *MAINTENANCE* section.

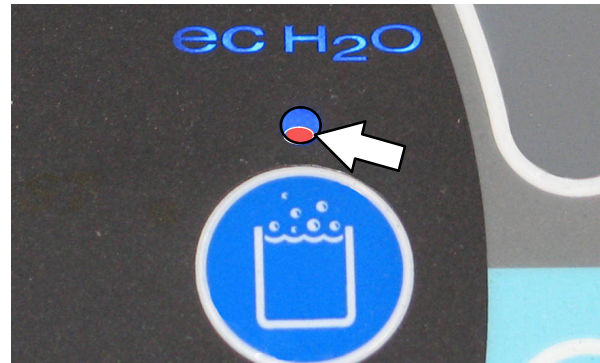

WARNING: Flammable materials or reactive metals can cause an explosion or fire. Do not pick up.

FOR SAFETY: When using machine, go slowly on inclines and slippery surfaces.

NOTE: The squeegee automatically rises when the machine is driven in reverse. This prevents damage to the squeegee.

7. Release the *Directional pedal* and press the *brake pedal* to stop the machine.
8. Press the *1-STEP* button to stop scrubbing. The light near the button will go off and scrubbing functions will stop after a short delay.

NOTE: If there is a fault code or warning code during machine operation (flashing warning / fault indicator light, a code displayed on the LCD, and an audible alarm), stop the machine and refer to the *FAULT INDICATORS* or *WARNING CODES* section of this manual for the cause and the corrective action for eliminating the fault or warning.

OPERATION

SCRUBBING – PRO-PANEL

FOR SAFETY: Do not operate machine, unless operator manual is read and understood.

1. Start the machine.
2. If applicable, log into the machine. See *PRO-ID LOGIN SCREEN*.
3. If applicable, complete the Pro-Check Pre-Operation Checklist. See *COMPLETING THE PRO-CHECK PRE-OPERATION CHECKLIST*.

NOTE: Make sure the scrubbing modes / settings are set before scrubbing.

4. Press the *1-STEP* button. The *1-STEP* button and all other selected scrubbing / sweeping buttons will illuminate.

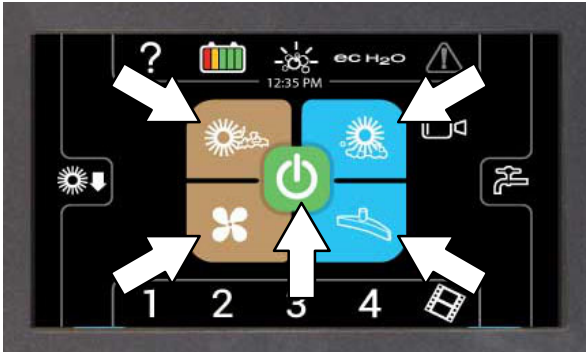

5. If necessary, adjust the scrubbing brush pressure and solution flow.

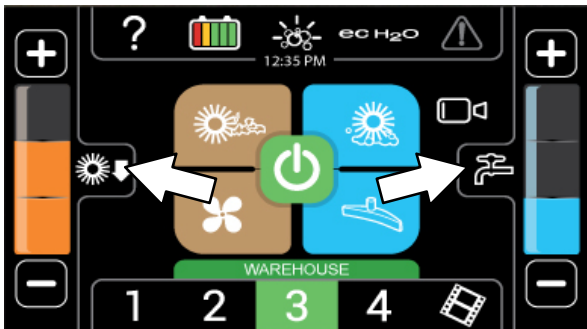

If necessary, activate the scrub mode or zone setting required for the area to be cleaned.

6. Release the parking brake.
7. Place the *directional switch* in the forward position.
8. Press the propel pedal to begin scrubbing.

NOTE: DO NOT turn on the ec-H2O system during conventional scrubbing. Conventional cleaning detergents could cause a ec-H2O system failure. Drain, rinse, and refill the solution tank with cool clean water before operating the ec-H2O system.

WARNING: Flammable materials or reactive metals can cause an explosion or fire. Do not pick up.

FOR SAFETY: When using machine, go slow on inclines and slippery surfaces.

NOTE: The squeegee automatically rises when the machine is driven backwards. This prevents damaging the squeegee.

9. Press the *rearview camera* button at any time to check cleaning performance behind the machine.



10. Release the *directional pedal* and press the *brake pedal* to stop the machine.
11. Press the *1-STEP* button to stop scrubbing. The button will no longer be illuminated and scrubbing / sweeping functions will stop after a short delay.

NOTE: If there is a fault or alert code during machine operation, stop the machine and refer to the FAULTS / ALERTS section of this manual for the cause and the corrective action for eliminating the fault or alert.

DOUBLE SCRUBBING

Double scrubbing is the process of making two or more passes over a heavily soiled area. The first pass is made with the rear and side squeegees raised to allow the solution to soak into the floor. Use the double scrubbing method to clean heavily soiled areas.

Double scrubbing can be performed using the *ec-H₂O* SCRUBBING SYSTEM (option), ES SCRUBBING SYSTEM (option), or CONVENTIONAL SCRUBBING methods.

Manually lift both side squeegee assemblies and position the double scrub latch to hold the squeegees in the raised position.

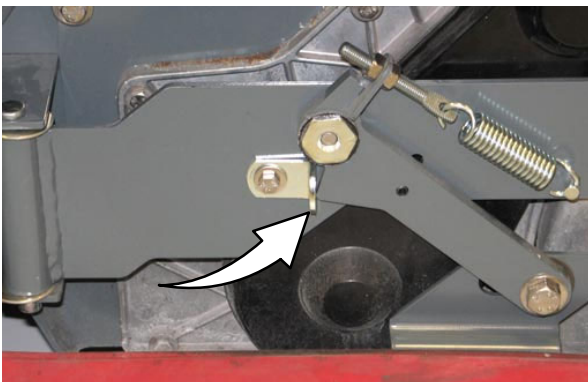

Press the *1-STEP* button and then the *Vacuum fan/squeegee* button. The light above the *Vacuum fan/squeegee* button will turn off, the squeegee will rise, and the vacuum fan will stop operating. Scrub the heavily soiled area. Let the cleaning solution soak on the floor for 5–15 minutes.

Machines equipped with standard panel: Press the *1-STEP* button and then the *vacuum fan / squeegee* button. The light above the *vacuum fan / squeegee* button will turn off, the squeegee will rise, and the vacuum fan will stop operating.

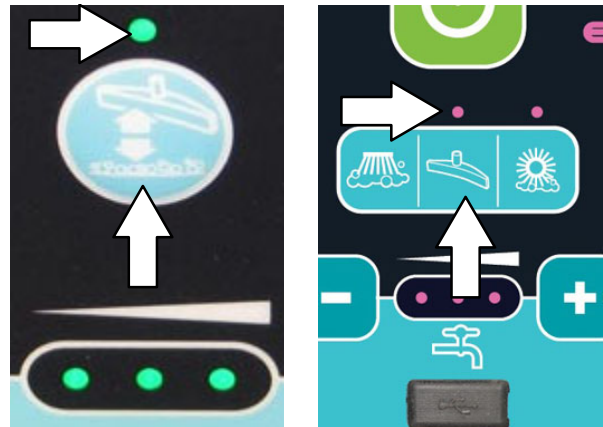

Machines equipped with Pro-Panel panel: Press the *1-STEP* button and then the *vacuum fan / squeegee* button. The *vacuum fan / squeegee* button will no longer be illuminated, the squeegee will rise, and the vacuum fan will stop operating.

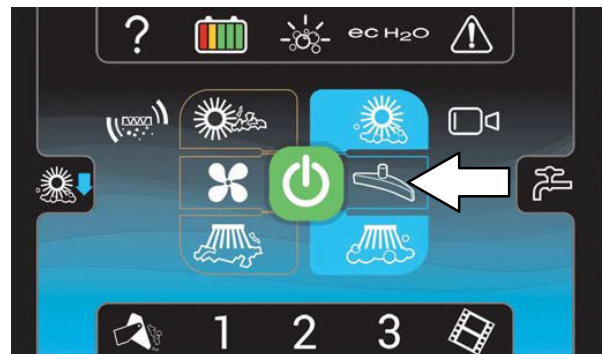

Scrub the heavily soiled area. Let the cleaning solution soak on the floor for 5–15 minutes.

FOR SAFETY: When using machine, go slowly on inclines and slippery surfaces.

OPERATION

Before scrubbing the floor a second time, lower the side squeegees and press the *Vacuum fan/squeegee button* to lower the rear squeegee and turn on the vacuum fan. The light above the button will come on. Scrub the floor a second time to pick up the cleaning solution.



WARNING: Flammable materials or reactive metals can cause an explosion or fire. Do not pick up.

NOTE: If needed, reduce solution flow when scrubbing the floor for a second time.

NOTE: Double scrubbing is not recommended in areas where the cleaning solution will run under racks or damage products.

WATER PICKUP MODE (NO SCRUBBING)

The machine can be used to pick up water or non-flammable liquid spills without scrubbing.

WARNING: Flammable materials or reactive metals can cause an explosion or fire. Do not pick up.

Before picking up water or non-flammable liquid spills, make sure the 1-STEP button is activated and all other cleaning functions are off.

Machines equipped with standard control panel: Press the *scrubbing vacuum fan / squeegee button*. The light above the button will illuminate, the squeegee will lower, and the vacuum fan will start operating. Pick up the water or non-flammable liquid spill.

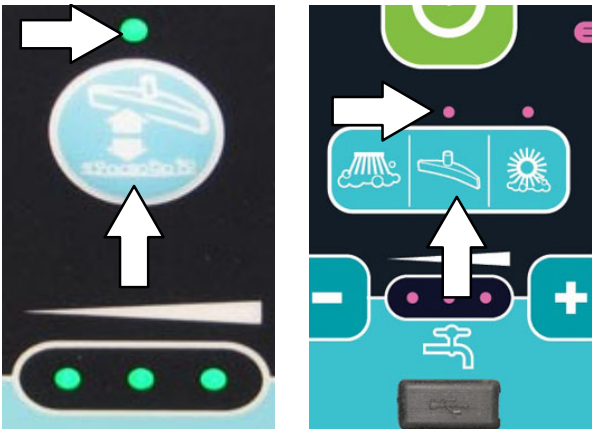

Machines equipped with Pro-Panel panel: Press the *scrubbing vacuum fan / squeegee button*. The button will illuminate, the squeegee will lower, and the vacuum fan will start operating. Pick up the water or non-flammable liquid spill.

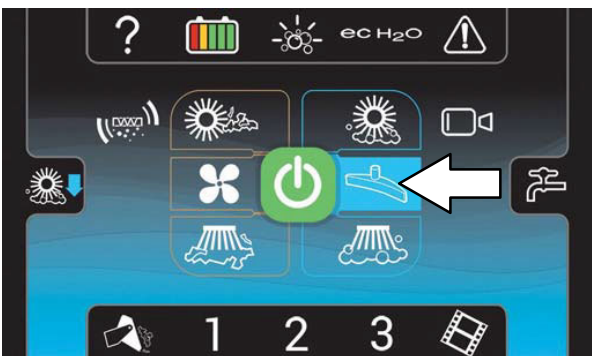

STOP SCRUBBING

1. While the machine is still in motion, press the *1-Step button* to stop the scrubbing operations. The squeegee will briefly remain lowered to the floor to pick up the water in the scrub head, and then raises.
2. Release the *Propel pedal* and press the *Brake pedal* to stop the machine.

OPERATION

DRAINING AND CLEANING THE RECOVERY TANK

Drain and clean the recovery tank daily or when the recovery tank full fault code appears on the LCD display.

Clean the outside of the tank with vinyl cleaner.

1. Drive the machine near a floor drain.
2. Lower the rear bumper door / step.

FOR SAFETY: Before leaving or servicing machine, stop on level surface, turn off machine, set parking brake, and remove key.

3. Unhook the recovery tank drain hose from the recovery tank.



4. Hold the drain hose near a floor drain, twist the drain nozzle open, and place the hose near the floor drain.

NOTE: Be sure the drain hose nozzle is pointed in a safe direction before opening the nozzle.



5. If necessary, twist the drain nozzle to another position to adjust the flow rate.

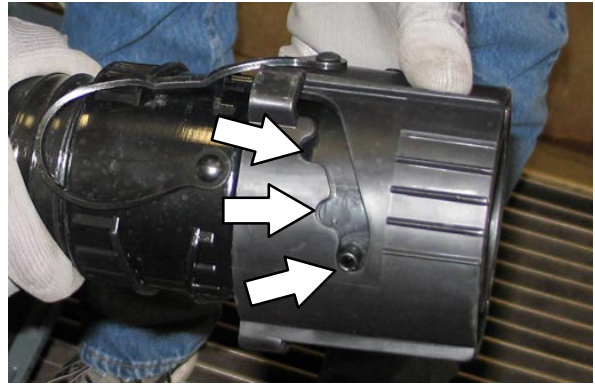

6. Lift the recovery tank cover and flush out the recovery tank with clean water. Rinse the sensor near the top of the tank.

ES machines only: Clean the second lower sensor (not shown).

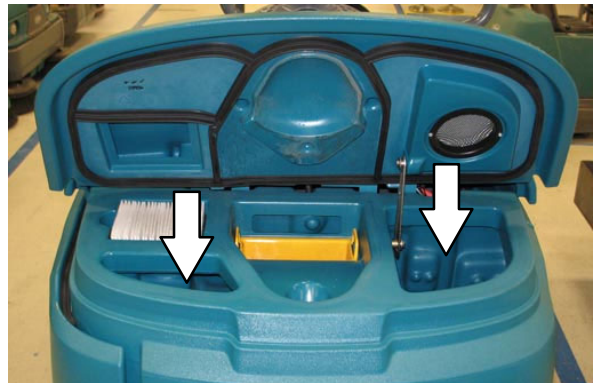

7. ES machines: Rinse the ES filter at the bottom of the recovery tank.

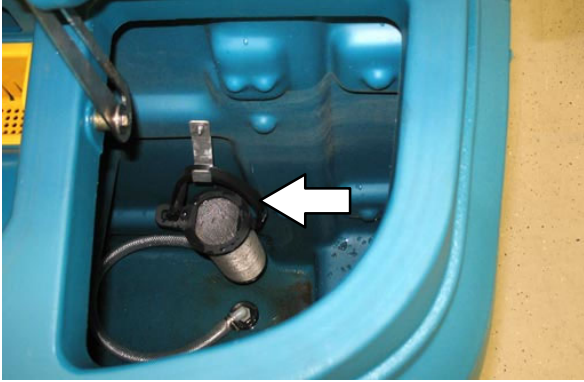

8. To prevent leaks, clean the plug portion of the nozzle and the interior of the drain hose cuff.

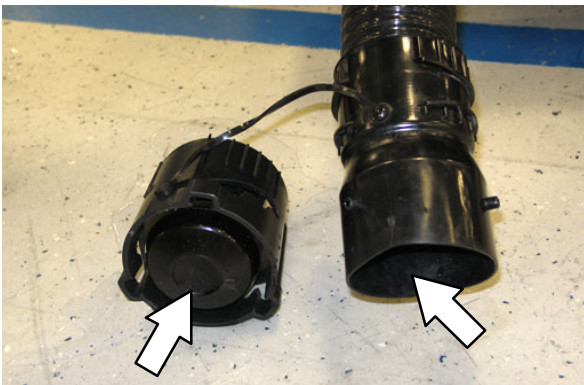

NOTE: DO NOT use steam to clean the tanks. Excessive heat can damage the tanks and components.

9. Twist the drain cuff closed and insert the drain hose back into the clip on the recovery tank.



10. Check the vacuum fan inlet filter daily. Clean inlet filter with a damp cloth or hose when dirty. Allow filter to completely dry before reinstalling it into the machine.



11. Remove the vacuum screen from the recovery tank cover and rinse the screen.



12. Remove the debris tray from the recovery tank and rinse all debris from the tray.



13. Close the recovery tank cover.

OPERATION

14. Cylindrical scrub head: Remove and clean the debris trough. Place the trough back in the scrub head when clean.



NOTE: The scrub head must be lowered approximately 25 mm (1 in) to remove debris trough.

NOTE: The debris trough can be removed from the right side of the machine only.

15. Raise the *Rear bumper door / step*.

DRAINING AND CLEANING THE SOLUTION TANK

Machines equipped with ES (Extended Scrub) only: Drain and clean the solution tank daily.

Clean the outside of the tank with vinyl cleaner.

1. Drive the machine near a floor drain.

FOR SAFETY: Before leaving or servicing machine, stop on level surface, turn off machine, set parking brake, and remove key.

2. Lower the rear bumper door / step.
3. Remove the solution tank drain hose from the solution tank.



4. Hold the drain hose near a floor drain, twist the drain nozzle open, and place the hose near the floor drain.

NOTE: Be sure the drain hose nozzle is pointed in a safe direction before opening the nozzle.



5. If necessary, twist the drain nozzle to another position to adjust the flow rate.

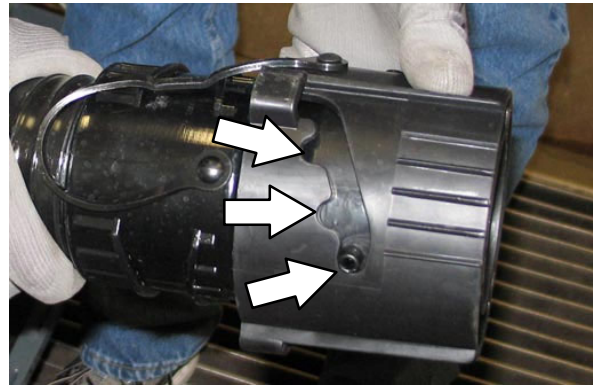

6. Twist the handle and lift the solution tank cover open and flush out the solution tank with clean water. Rinse the ES filter located at the bottom of the tank.

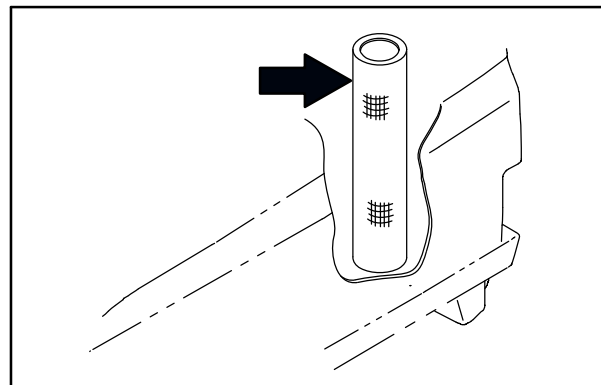

NOTE: DO NOT use steam to clean the tanks. Excessive heat can damage the tanks and components.

OPERATION

7. To prevent leaks, clean the plug portion of the nozzle and the interior of the drain hose cuff.

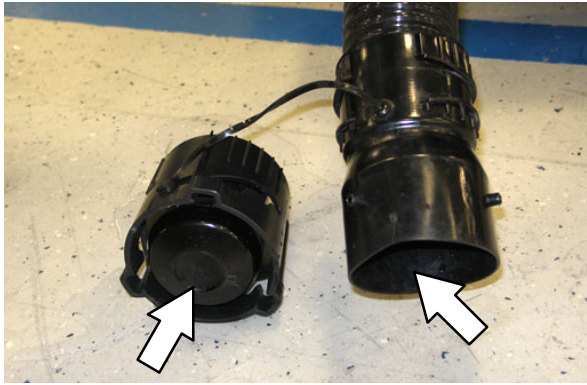

8. Twist the drain cuff closed and insert the drain hose back into the clip on the solution tank.



9. Raise the *Rear bumper door / step*.

TURN OFF THE MACHINE

1. Remove foot from the *Propel pedal*.
2. Press the *1-Step button* to stop scrubbing.
3. Press the *Brake pedal* to stop the machine.
4. Turn the *Key switch* to the OFF position and remove the key.

FOR SAFETY: Before leaving or servicing machine, stop on level surface, turn off machine, set parking brake, and remove key.

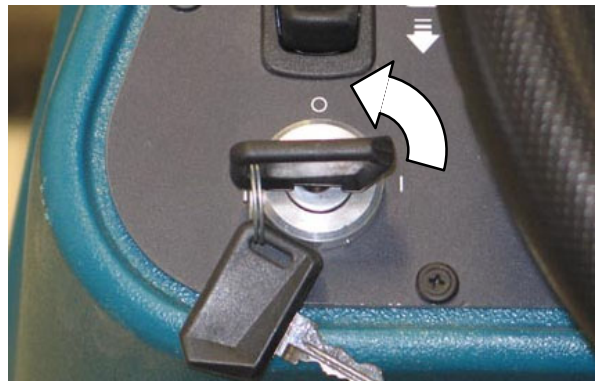

FAULT INDICATORS

This machine is equipped with two visual indicators, a red indicator light and an LCD (liquid crystal display).

The red indicator light will blink continuously indicating that a fault has occurred.

The LCD will display a fault code. If there is more than one fault, each fault code will alternately display.

All fault codes are also accompanied by an audible alarm to alert the operator a fault has occurred.

To reset the fault indicators, turn the machine off, then eliminate the cause of the fault. The fault indicator will reset when the machine is restarted.

Refer to the table below to determine the cause and remedy for the fault.

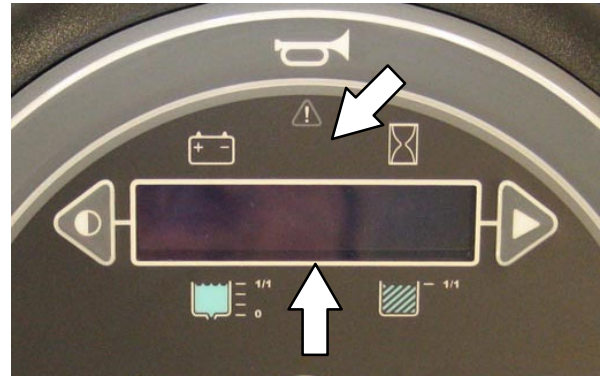

Fault Code (Displayed in LCD)	Cause(s)	Remedy
F1:Rcv Tank Full	Recovery tank is full	Empty recovery tank
F2: Sol Tank Empty	Solution tank is empty	Fill solution tank
F3: Batt Very Low	Low battery charge	Recharge battery
F4: F/L Br Flt###	Front left brush not operating	Turn off and restart machine. If fault code still appears, stop using machine and contact Tennant service representative
F5: R/R Br Flt###	Right rear brush not operating	
F6: Vac 1 Short	Vacuum fan 1 not operating	
F7: Vac 2 Short	Vacuum fan 2 not operating	
F8: Check Brushes	Brushes not operating	Check Brushes. Replace excessively worn brushes. Turn off and restart machine. If fault code still appears, stop using machine and contact Tennant service representative
F9: Propel Error	All scrub functions inoperable (1-Step does not function)	Turn off and restart machine. If fault code still appears, stop using machine and contact Tennant service representative
F10: Pickup Error	All scrub functions inoperable (1-Step does not function)	
F11: Scrub Error	All scrub functions inoperable (1-Step does not function)	

OPERATION

WARNING CODES / WARNING CODES

The operator will receive a fault / alert warning when there is a mechanical / electronic issue with the machine.

All fault codes are accompanied by an audible alarm to alert the operator a fault has occurred.

To reset the fault / alert indicators, turn off the machine and then eliminate the cause of the fault / alert. The fault / alert indicator will reset when the machine is restarted.

Refer to the fault / alert indicators table to determine the cause and remedy for the fault / alert.

FAULT / ALERT INDICATORS – STANDARD PANEL

This machine is equipped with two visual indicators, a red indicator light and an LCD (liquid crystal display).

The red indicator light will blink continuously indicating that a fault has occurred.

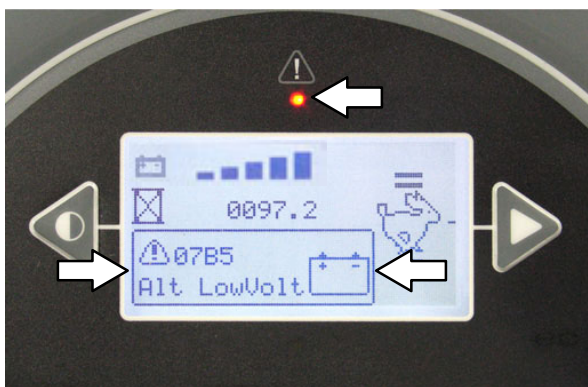
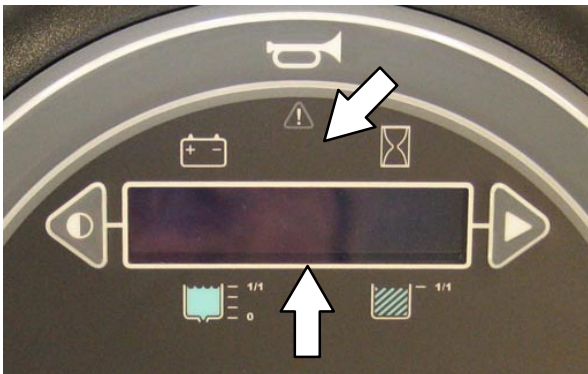



The LCD will display a fault code. If there is more than one fault, each fault code will alternately display.

FAULT / ALERT INDICATORS – PRO-PANEL

The *fault / alert indicator button* will flash continuously indicating a fault / alert has occurred. The multicolored background will change to a black background.





 Press the flashing *red fault indicator button* to view the faults. A fault / alert screen will appear in the display.

 Press the flashing *yellow alert indicator button* to view the alerts. A fault / alert screen will appear in the display.

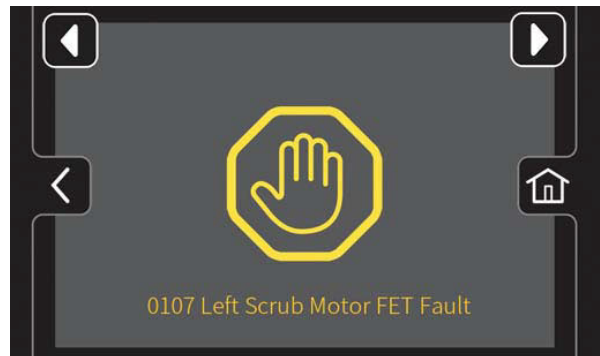
Fault / alert text will appear under the icon in the center of the screen



 Press *right arrow button* to scroll forward through the faults / alerts.

 Press *left arrow button* to scroll back through the faults / alerts.

 Press the *home button* to return to the main operating screen.

 Press the *back button* to return to the previous screen.

FAULT / WARNING CODES
(S/N 0000–1199)

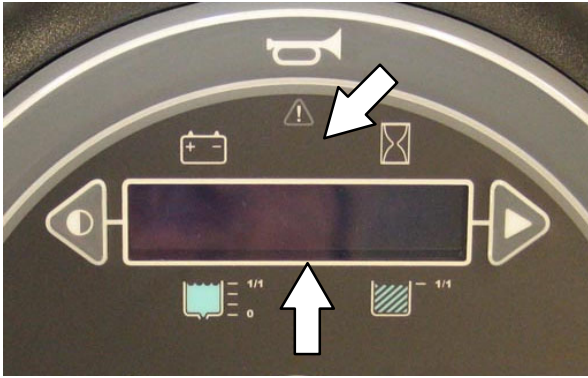

Refer to the table below to determine the cause and remedy for the fault.

Fault Code (S/N 0000–1199) (Displayed in LCD)	Cause(s)	Remedy
F1:Rcv Tank Full	Recovery tank is full	Empty recovery tank
F2: Sol Tank Empty	Solution tank is empty	Fill solution tank
F3: Batt Very Low	Low battery charge	Recharge battery
F4: F/L Br Flt##	Front left brush not operating	Turn off and restart machine. If fault code still appears, stop using machine and contact Tennant service representative
F5: R/R Br Flt##	Right rear brush not operating	
F6: Vac 1 Short	Vacuum fan 1 not operating	
F7: Vac 2 Short	Vacuum fan 2 not operating	
F8: Check Brushes	Brushes not operating	
F9: Propel Error	All scrub functions inoperable (1–Step does not function)	Turn off and restart machine. If fault code still appears, stop using machine and contact Tennant service representative
F10: Pickup Error	All scrub functions inoperable (1–Step does not function)	
F11: Scrub Error	All scrub functions inoperable (1–Step does not function)	

OPERATION

Fault Code (S/N 0000–1199) (Displayed in LCD)	Cause(s)	Remedy
W1: Batt. Low	Low battery charge.	Charge batteries.
W2: Unavailable	Neither ES nor ec-H2O is enabled.	Selected scrub mode (ES / ec-H2O) not available. Appears while machine is in transport mode (<i>1-Step</i> not enabled).
W3: No [Side / Sweep] Config	Side brush not enabled.	Side brush not available. Pre-Sweep not available.
W4: Not Active	Selected function is inactive.	Press the <i>1-Step button</i> to activate all functions.
W5: Solution Off	Solution supply not enabled.	Enable solution supply.
W6: Brake On	Parking brake is engaged.	Release parking brake.
W7: Side Br Wrn##	Scrubbing side brush inoperable.	Turn off and restart machine. If fault code still appears, stop using machine and contact Tennant service representative.
W8: L Side Br Short	Left sweeping side brush inoperable.	
W9: R Side Br Short	Right sweeping side brush inoperable.	
W10: L Sweep Br Shrt	Left Pre-Sweep brush inoperable.	
W11: M Sweep Br Shrt	Main Pre-Sweep brush inoperable.	
W12: R Sweep Br Shrt	Right Pre-Sweep brush inoperable.	
W13: Open [Frnt/Left] Br	Front main brush inoperable.	Check corresponding circuit breaker. Check harness connection. Reconnect harness if it is unconnected. If fault code still appears, stop using machine and contact Tennant service representative.
W14: Open [Rear/Right] Br	Rear main brush inoperable.	
W15: Open Side Brush	Scrubbing side brush inoperable.	
W16: Open L Side Br	Left sweeping side brush inoperable.	
W17: Open R Side Br	Right sweeping side brush inoperable.	
W18: Open L Sweep Br	Left Pre-Sweep brush inoperable.	
W19: Open M Sweep Br	Main Pre-Sweep brush inoperable.	
W20: Open R Sweep Br	Right Pre-Sweep brush inoperable.	
W21: Sweep Vac Shrt	Pre-Sweep vacuum fan inoperable.	Turn off and restart machine. If fault code still appears, stop using machine and contact Tennant service representative.
W22: Open Vac 1	Vacuum fan 1 inoperable.	Check corresponding circuit breaker. Check harness connection. Reconnect harness if it is unconnected.
W23: Open Vac 2	Vacuum fan 2 inoperable.	
W24: Open Sweep Vac	Pre-Sweep vacuum fan inoperable.	If fault code still appears, stop using machine and contact Tennant service representative.
W25: SqueegeeStall	Rear squeegee not lowering.	Check squeegee / squeegee actuator for obstructions. Clear obstructions. If fault code still appears, stop using machine and contact Tennant service representative.

Fault Code (S/N 0000–1199) (Displayed in LCD)	Cause(s)	Remedy
W26: Side Stall	Scrubbing side brush / side brush motor is obstructed.	Check brush / brush motor for obstructions. Clear obstructions. If fault code still appears, stop using machine and contact Tennant service representative.
W27: LSide Stall	Left sweeping side brush / side brush motor is obstructed.	
W28: RSide Stall	Right sweeping side brush / side brush motor is obstructed.	
W29: Sweep Stall	Pre–Sweep is not lowering.	Check Pre–Sweep actuator for obstructions. Clear obstructions. If fault code still appears, stop using machine and contact Tennant service representative.
W30: DetPumpShort	Detergent pump inoperable.	Turn off and restart machine. If warning code still appears, stop using machine and contact Tennant service representative.
W31: ES PumpShort	ES pump inoperable.	
W32: SidePumpShrt	Scrubbing side brush pump inoperable.	
W33: Ec Pump Shrt	ec–H2O pump inoperable.	
W34: DetPumpOpen	Detergent pump inoperable.	Check corresponding circuit breaker. Check harness connection. Reconnect harness if it is unconnected. If fault code still appears, stop using machine and contact Tennant service representative.
W35: ES PumpOpen	ES pump inoperable.	
W36: SidePumpOpen	Scrubbing side brush pump inoperable.	
W37: Ec Pump Open	ec–H2O pump inoperable.	
W38: [Side / Sweep] Offline	Sweeping or scrubbing side brush, or Pre–Sweep inoperable.	Turn off and restart machine. If warning code still appears, stop using machine and contact Tennant service representative.
W39: ECH2O Offline	ec–H2O system inoperable.	Turn off and restart machine. If warning code still appears, stop using machine and contact Tennant service representative.

NOTE: Contact a Tennant Service representative for all other fault codes.

OPERATION

FAULT / WARNING CODES (S/N 01200-)



Standard Panel

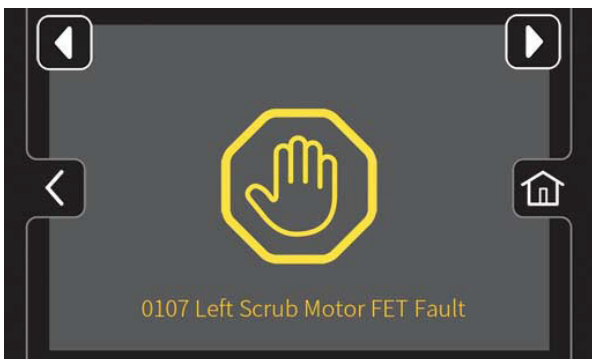

Pro Panel

Refer to the table below to determine the cause and remedy for the fault.

Fault Code (S/N 1200-) (Displayed in LCD)	Cause(s)	Remedy
0010 Parking Brake On	Parking brake is engaged.	Release parking brake.
0701 ECH2O Flush Needed	Ec-H2O system plugged with impurities	Flush ec-H2O system
0781 Detergent Tank Empty	Detergent tank is empty	Fill detergent tank
0790 Solution Tank Empty	Solution tank is empty	Fill solution tank
0791 Recovery Tank Full	Recovery tank is full	Empty recovery tank
0792 Solution Off	Solution supply not enabled.	Enable solution supply.
07A4 Seat Empty	Operator is not in seat	Return to seat
FF11 Low Battery Warning	Low battery charge.	Charge battery
FF12 Very Low Battery Warning	Low battery charge	Charge battery
FFF0 E-Stop Pushed	Emergency stop engaged	Release emergency stop

NOTE: Contact a Tennant Service representative for all other fault codes.

OPTIONS

SPRAY NOZZLE (OPTION)

The spray nozzle is used to clean the machine and surrounding areas. The solution tank provides a water/solution supply for the spray nozzle.

FOR SAFETY: When servicing machine, do not power spray or hose off machine near electrical components.

FOR SAFETY: Before leaving or servicing machine and stop on level surface and set parking brake.

1. Turn on the machine.
2. Press the top of the *Spray nozzle switch* to turn on the spray nozzle. The light on the switch will come on when the spray nozzle is turned on.



3. Open the left shroud to access the spray nozzle.

4. Pull the spray nozzle out from the back of the machine and clean as needed.



5. When finished cleaning, gently pull the hose and allow the spray nozzle hose to retract back into the machine.

NOTE: Continue holding onto the spray nozzle and control the hose while it is retracting back into the machine. The machine and / or the spray nozzle assembly could be damaged if the spray nozzle hose is released and allowed to rapidly retract into the machine.

6. Press the bottom of the *Spray nozzle switch* to turn off the water supply. The light on the switch will turn off when the spray nozzle is turned off.

NOTE: Be sure the Spray nozzle switch is turned off before continuing scrubbing. The spray nozzle pump could be damaged if the switch is left on while scrubbing.

OPERATION

HIGH PRESSURE WASHER (OPTION)

The high pressure washer is used for heavy duty cleaning. Do not use detergent in the solution tank when using the pressure washer or pressure washer damage could occur.

NOTE: Before using the high pressure washer for the first time or if the solution tank was completely drained, prime the high pressure washer pump. See PRIMING THE HIGH PRESSURE WASHER PUMP.

FOR SAFETY: When servicing machine, do not power spray or hose off machine near electrical components.

FOR SAFETY: Before leaving or servicing machine, stop on level surface, turn off machine, set parking brake, and remove key.

1. Turn off the machine and set the parking brake.

NOTE: The high pressure washer will not operate unless the parking brake is set.

2. Unlatch the hose tie down and remove the pressure washer hose from the machine.



3. Unlatch the pressure washer wand tie down and remove the wand from the machine from the machine.



4. Connect the hose to the high pressure washer system.

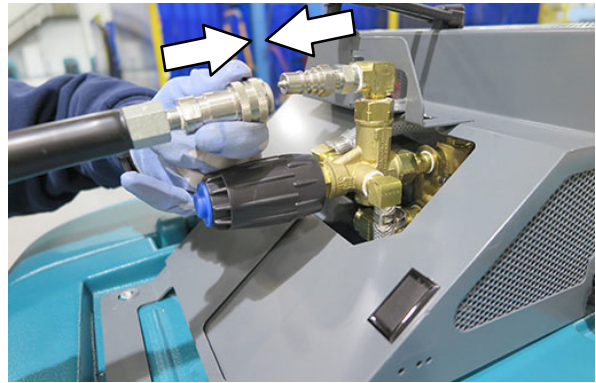

5. Connect the other end of the hose to the wand.

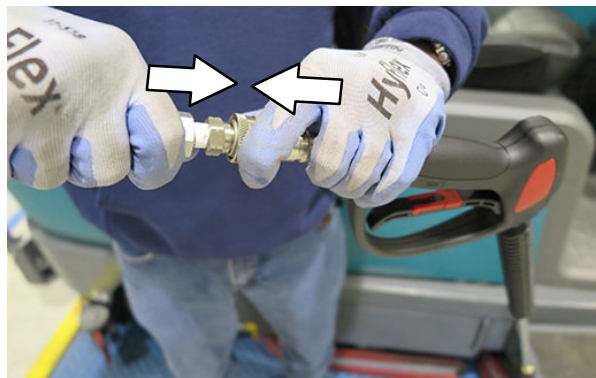

6. Adjust the nozzle on the wand to the desired setting.

Pull the nozzle out for the **Low** pressure setting, or push the nozzle in for the **High** pressure setting. Twist the nozzle for either the **Stream** or **Fan** setting.



7. Start the machine.

8. Verify that the 1-STEP Scrub button is off.

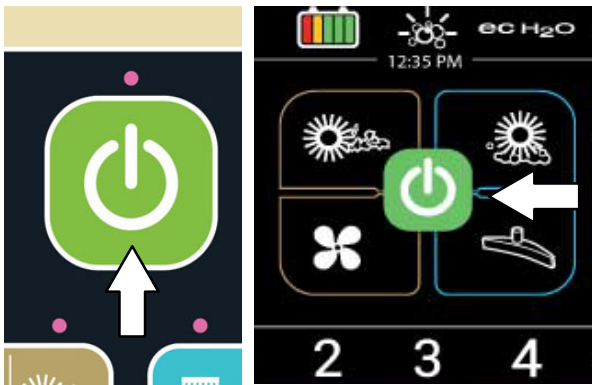

Standard Panel

Pro-Panel

9. Press the top of the High pressure washer switch to turn on the high pressure washer. The light on the switch will come on when the high pressure washer is turned on.

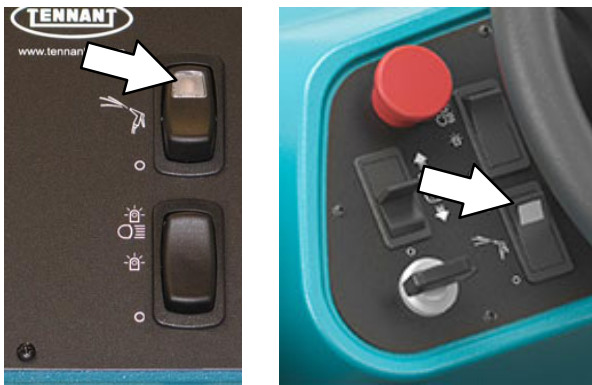

10. If necessary, adjust the pressure. Turn the knob clockwise to increase pressure and counterclockwise to decrease pressure.

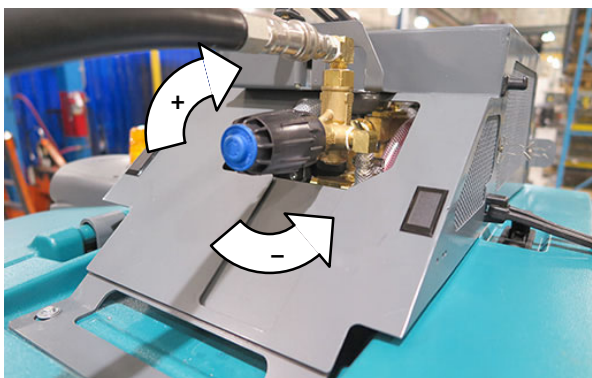

NOTE: Adjust the pressure at the wand before adjusting it at the system.

11. Squeeze the trigger to begin cleaning.

WARNING: Do not spray people or animals. Severe personal injury can result. Wear eye protection. Hold sprayer with two hands.

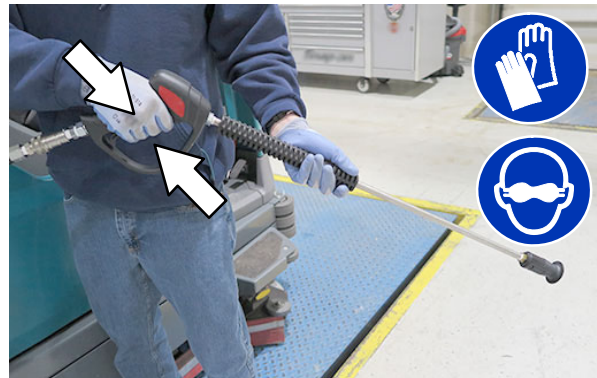

12. When finished cleaning, release the trigger.

13. Press the bottom of the Pressure washer switch to turn off the high pressure washer.

14. Point the high pressure washer wand in a safe direction and squeeze the trigger to relieve pressure from the system.

15. Turn off the machine.

16. Disassemble the hose and wand and return them to the proper storage locations.

OPERATION

PRIMING THE HIGH PRESSURE WASHER PUMP

The high pressure washer pump needs to be primed before operating for the first time or if the solution tank was completely drained. To prime the system, the solution pump must be run to bring water/solution to the high pressure washer pump before operating the high pressure washer pump.

FOR SAFETY: Before leaving or servicing machine, stop on level surface, turn off machine, set parking brake, and remove key.

1. Turn off the machine and set the parking brake.
2. Chock the rear wheels.
3. Connect the hose and wand to the high pressure washer system.
4. Start the machine.
5. Release the parking brake.

NOTE: This prevents damaging the high pressure pump from operating with no water/solution in the pump.

6. Press the top of the *High pressure washer switch* to activate the solution pump. The light on the switch will come on when the high pressure washer is turned on.



7. Squeeze and hold the trigger until water/solution flows out the wand.

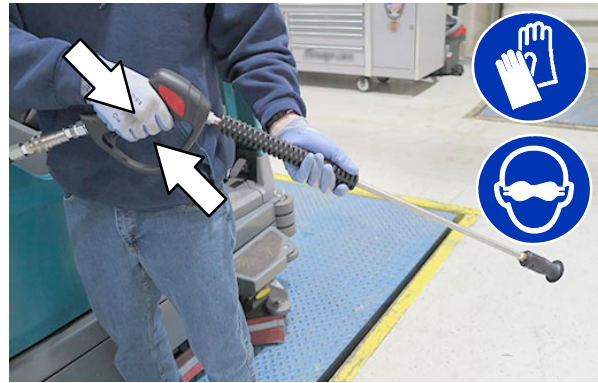

8. Release the trigger.
9. Press the bottom of the *high pressure washer switch* to turn off the high pressure washer.
10. Turn off the machine and set the parking brake.
11. The high pressure washer pump is now primed.

WET VACUUM WAND (OPTION)

Use the vacuum wand to clean areas that are out of reach of the machine.

WARNING: Flammable materials or reactive metals can cause an explosion or fire. Do not pick up.

FOR SAFETY: Before leaving or servicing machine and stop on level surface and set parking brake.

1. Lower the rear bumper door / step.
2. Remove the vacuum wand components from the storage tray located on top the battery compartment cover.



3. Disconnect the vacuum hose from the rear squeegee.



4. Connect the vacuum wand hose to the rear squeegee vacuum hose.

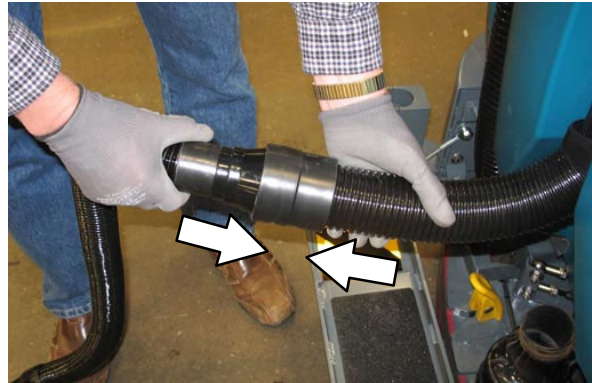

5. Connect the vacuum wand nozzle to the vacuum wand nozzle hose.



6. Insert and tighten the vacuum wand handle into the vacuum wand nozzle.



OPERATION

- Secure the vacuum wand hose collar to the vacuum hose handle.



- Extend the vacuum wand handle to the desired length and twist the vacuum wand handle to tighten.

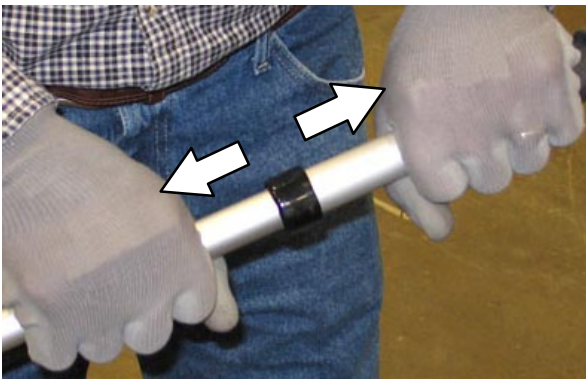

- Turn on the machine.

- Press the *Vacuum fan/squeegee button* to turn on the vacuum fan. The squeegee will completely lower.

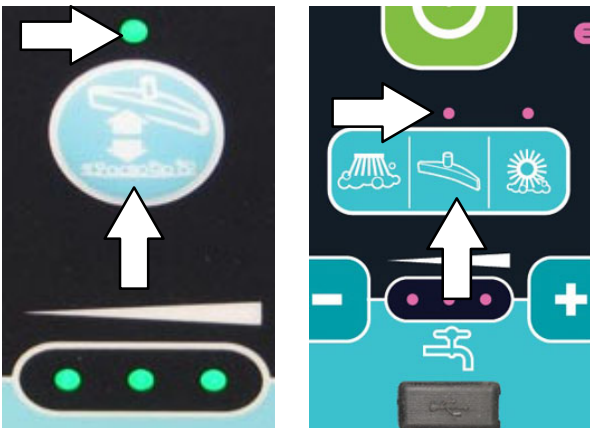

Standard Panel



Pro-Panel

- Vacuum the floor.



- When finished vacuuming, press the *Vacuum fan/squeegee button* to turn off the vacuum fan. The squeegee will raise.

- Turn off the machine.

- Disconnect the vacuum wand hose from the rear squeegee vacuum hose and disassemble the vacuum wand.

- Return the vacuum wand components to the storage tray located on top the battery compartment cover.

- Reconnect the vacuum hose to the rear squeegee.

- Lift the rear bumper door / step to the raised position and secure to the rear bumper.

LIVE WAND (OPTION)

The live wand uses a separate vacuum system to pick up dry debris that could get tangled in the cleaning system. The dry vacuum system can be used separately off the machine or on the machine with an operator sitting in the seat.

OPERATING THE LIVE WAND (OFF MACHINE)

FOR SAFETY: Before leaving or servicing machine, stop on level surface, turn off machine, set parking brake, and remove key.

1. Remove the live wand from its storage location.



2. Turn on the machine.
3. Turn on the live wand switch.

NOTE: The live wand will not operate while off the machine unless the machine parking brake is set.



4. Vacuum dry debris as needed.
5. Turn off the live wand switch and return the live wand to storage location when finished.

OPERATING THE LIVE WAND (ON MACHINE)

1. Move the live wand from the storage location to the *ready-to-use* position.



2. Turn on the live wand switch.

NOTE: The live wand will not turn on until it is removed from the read-to-use position.

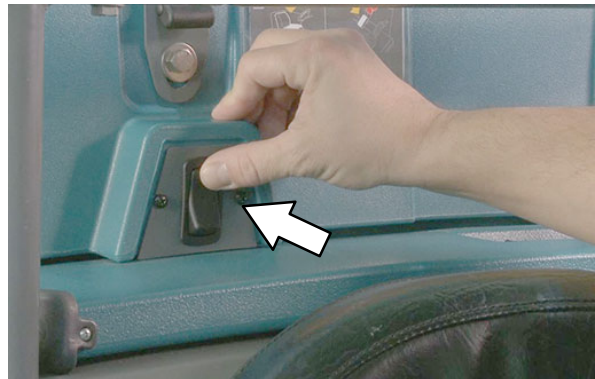

3. Operate the machine normally until the live wand is needed.



OPERATION

4. Lift the live wand from the *ready-to-use* position and vacuum dry debris as needed. The vacuum will start automatically.



NOTE: The machine speed will decrease when the live wand is removed from the ready to use position.

5. Place the live wand into the *ready-to-use* storage location when finished. Make sure the wand is secured properly which turns off the vacuum.

EMPTYING THE LIVE WAND VACUUM DEBRIS TRAY

The live wand collects dry debris in a vacuum debris tray. Empty the vacuum debris tray daily.

FOR SAFETY: Before leaving or servicing machine, stop on level surface, turn off machine, set parking brake, and remove key.

1. Unlatch and open the live wand vacuum cover.

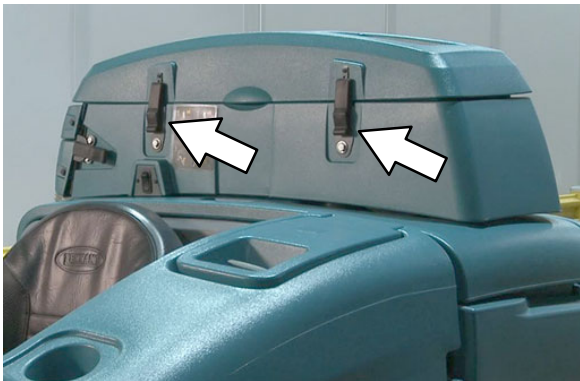

2. Unlatch and remove the live wand hose.

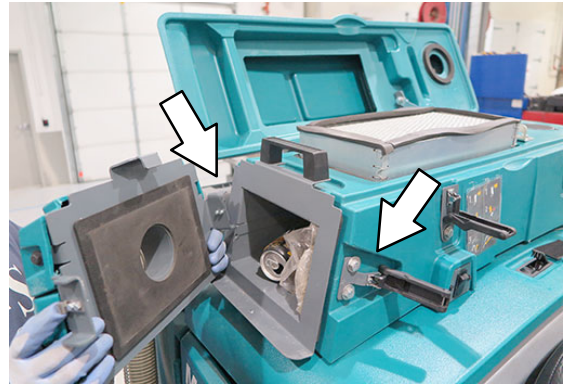

3. Hang the live wand hose on the hanging bracket.

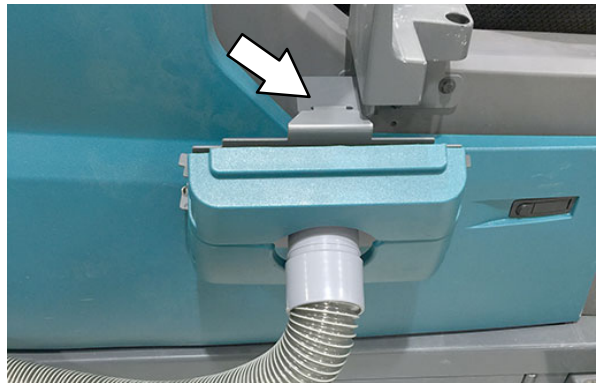

4. Remove and empty the debris tray. Place the tray back in the vacuum chamber.

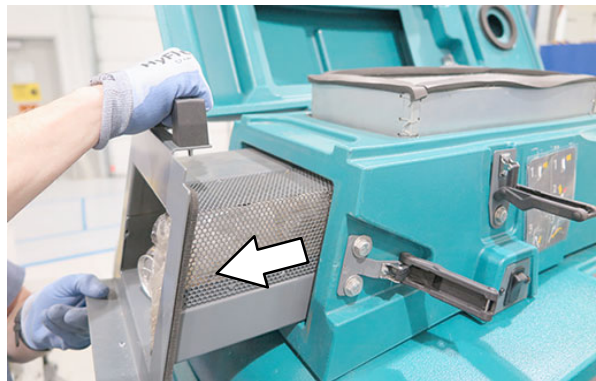

5. Replace and latch the live wand vacuum hose.

6. Close and latch the live wand vacuum cover.

CLEAN THE LIVE WAND VACUUM FILTER

Clean the live wand vacuum filter every 50 hours of operation.

FOR SAFETY: Before leaving or servicing machine, stop on level surface, turn off machine, set parking brake, and remove key.

1. Unlatch and open the live wand vacuum cover.
2. Remove the live wand vacuum filter and use one of the following methods to clean the dust filter.



TAPPING – Tap the filter, with the dirty side down, gently on a flat surface. **Do not damage the edges of the filter.** The filter will not seal properly in the filter frame if the edges of the filter are damaged.

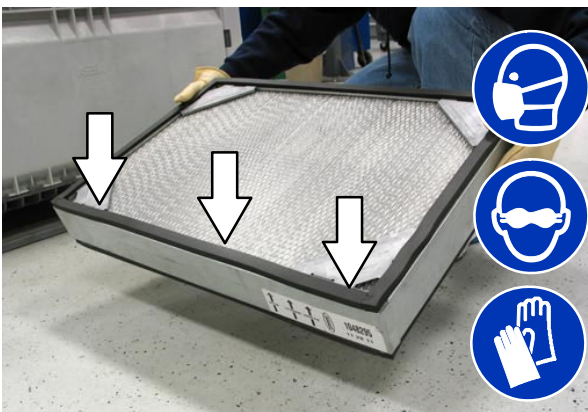

AIR–Always wear eye protection when using compressed air. Blow air through the dust filter opposite the direction of the arrows. Never use more than 690 kPa (100 psi) of air pressure and never hold the nozzle closer than 50 mm (2 in) to the filter. This may be done with the dust filter in the machine.

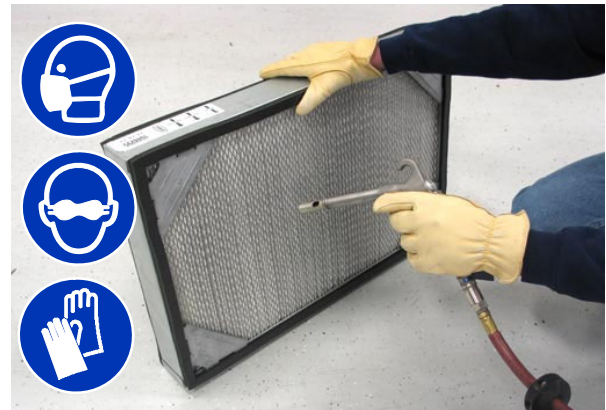

3. Reinstall the filter, close the live wand vacuum cover and latch it when finished.

OPERATION

REAR SQUEEGEE GUARD (OPTION)

The rear squeegee protector helps protect the rear squeegee from being damaged.

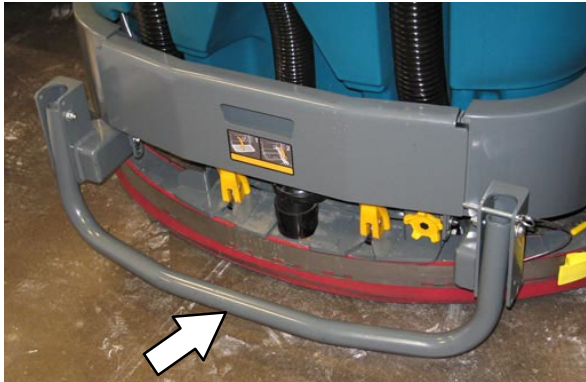

To engage the rear squeegee protector, pull the pin, lower the protector bar, and reinsert the pin.



SCRUBBING OR SWEEPING SIDE BRUSH (OPTION)

The side brush moves debris into the path of the main brushes. Solution is dispensed with the side brush when the machine is equipped with the scrubbing side brush. No solution is dispensed with the side brush when the machine is equipped with the sweeping side brush.

WARNING: Flammable materials or reactive metals can cause an explosion or fire. Do not pick up.

1. Turn on the machine
2. Press the top of the *Side brush* switch to enable the side brush assembly.

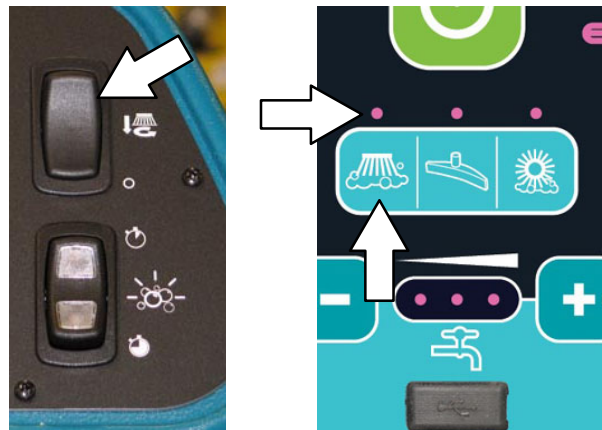

Standard Panel



Pro-Panel

3. Press the *1-Step* button. The side brush assembly will lower with the main brush.

NOTE: The *1-Step* button controls the side brush assembly when the *Side brush* switch is in the *On* (top) position.

4. Press the *Propel* pedal to begin scrubbing.
5. Press the bottom of the *Side brush* switch to stop and raise the side brush.

PRE-SWEEP ASSEMBLY (OPTION)

The Pre-Sweep assembly is mounted to the front of the machine and gives the machine the added ability to pick up debris. The assembly contains a main brush and two side brushes which sweep debris into a debris hopper. Periodically empty the debris hopper and vacuum debris bag.

The machine may be operated with or without the Pre-Sweep assembly. Refer to PRE-SWEEP in the MAINTENANCE section for maintenance.

! WARNING: Flammable materials or reactive metals can cause an explosion or fire. Do not pick up.

OPERATE PRE-SWEEP (OPTION) WITH STANDARD PANEL

1. Turn on the machine
2. Press the 1-Step button to scrub and operate the Pre-Sweep.

NOTE: Do not press the 1-Step button if only using to sweep. The Pre-Sweep can be used without the scrubbing features.

3. Press the top of the Pre-Sweep switch to start the Pre-Sweep without dust control. The top portion of the switch will illuminate.

Press the bottom of the Pre-Sweep switch to start the Pre-Sweep with dust control. The bottom portion of the switch will illuminate.

NOTE: The Pre-Sweep assembly will begin sweeping and the dust control system will start operating when the machine propels forward.

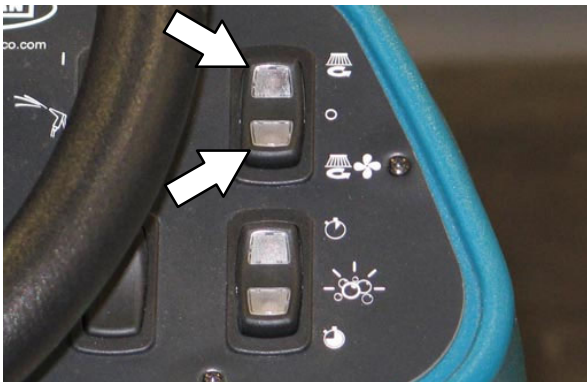

4. Press the illuminated portion (top or bottom) of the Pre-Sweep switch to shut off the Pre-sweep system and dust control system.

OPERATE PRE-SWEEP (OPTION) WITH PRO-PANEL

1. Turn on the machine
2. Press the 1-Step button to scrub and operate the Pre-Sweep.

NOTE: Do not press the 1-Step button if only using to sweep. The Pre-Sweep can be used without the scrubbing features.

3. Press the Pre-Sweep brush button to start the Pre-Sweep without dust control.

Press the Pre-Sweep Vacuum button to start the Pre-Sweep dust control.



NOTE: The Pre-Sweep assembly will begin sweeping and the dust control system will start operating when the machine propels forward.

4. Press the Pre-Sweep brush or Pre-Sweep Vacuum button to shut off the Pre-sweep system and dust control.

OPERATION

EMPTY THE PRE-SWEEP DEBRIS HOPPER

FOR SAFETY: Before leaving or servicing machine, stop on level surface, turn off machine, set parking brake, and remove key.

1. Loosen both Pre-Sweep cover latches.



2. Lift the Pre-Sweep cover and engage the Pre-Sweep cover support to lock the cover open.



3. Remove the debris hopper from the Pre-Sweep assembly and empty the hopper.



4. Reinstall the debris hopper into the Pre-Sweep assembly.
5. Check the vacuum debris bag. Replace the vacuum debris bag if it is full or damaged.



6. Disengage the Pre-Sweep cover support and lower the Pre-Sweep cover.

ADJUSTING BACKUP ALARM VOLUME (OPTION)

FOR SAFETY: When using machine, follow site safety guidelines concerning backup alarms.

The backup alarm volume can be adjusted from 85–102 dB(A). To adjust the volume, remove the backup alarm cover and turn the volume knob.

Increase volume: Turn the knob clockwise.

Decrease volume: Turn the knob counter-clockwise.

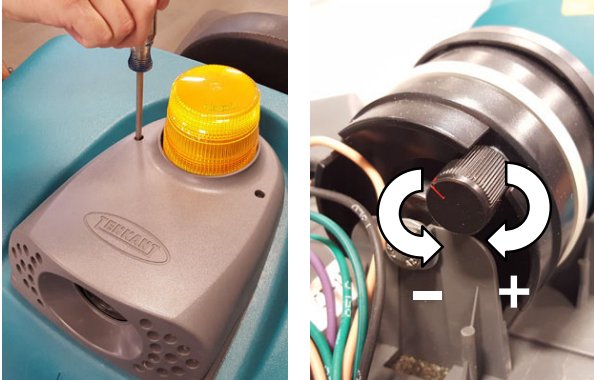

OPERATION

SLIDE OUT BATTERY (OPTION)

The slide out battery allows the operator a quick and easy way to remove and replace the batteries. Use proper battery pulling and lifting equipment and procedures based on the battery size and weight. See *SPECIFICATIONS* section. The battery slide out height is 508 mm (20 in).

FOR SAFETY: Before leaving or servicing machine, stop on level surface, turn off machine, set parking brake, and remove key.

1. Lift the battery compartment cover open and engage the support.

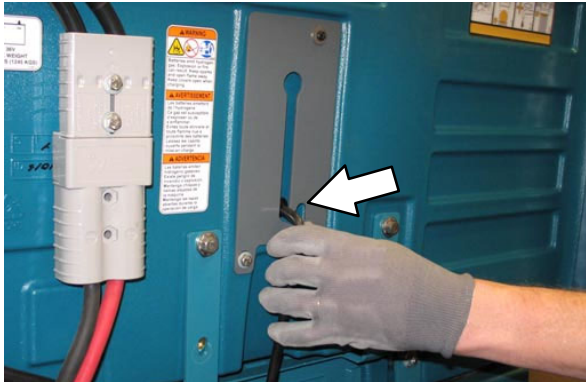

2. Open the right shroud.

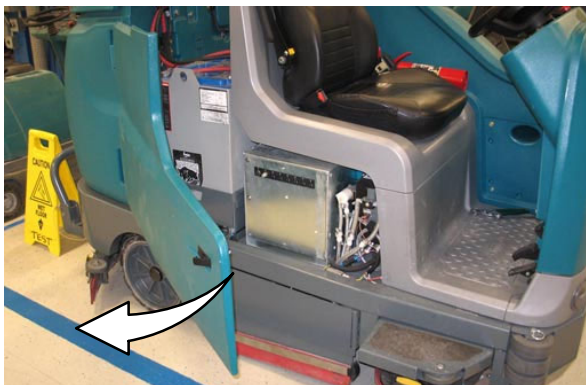

3. Disconnect the battery side cable connector from the machine by pulling down on the connector. Do not pull on the cables.

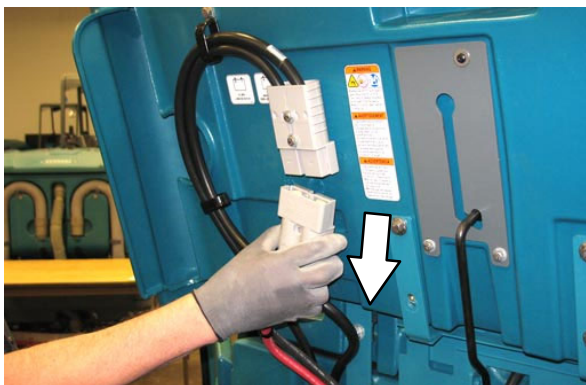

4. Remove the battery retainer plate from the machine.



5. Position the battery cart near the battery compartment.

FOR SAFETY: When servicing machine: Keep all metal objects off batteries. Use a non-conductive battery removal device. Use a hoist and adequate assistance when lifting batteries. Battery installation must be done by trained personnel. Follow site safety guidelines concerning battery removal.

6. Slide the battery from the machine and onto the battery cart.

7. Install the new battery into the battery compartment.

8. Reinstall the battery retainer plate onto the machine. The retainer plate must press the switch completely down into the engaged position. The machine will not function if the switch is not engaged.

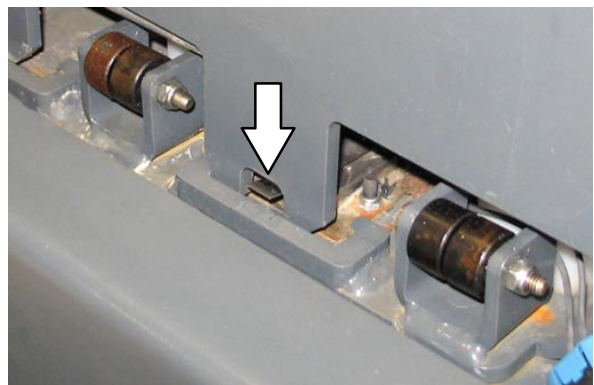

9. Close the battery compartment side cover and top cover.

MACHINE TROUBLESHOOTING

Problem	Cause	Remedy
Machine will not operate	Emergency stop button activated	Turn button clockwise to reset
	Machine fault detected	See FAULT INDICATORS or WARNING CODES
	Discharged battery	Charge battery
	Loose battery cable(s)	Tighten loose cable(s)
	Faulty battery	Replace battery
	Faulty key switch	Contact Tennant service representative
	Faulty control board	Contact Tennant service representative
Trailing water – poor or no water pickup	Worn squeegee blades	Rotate or replace squeegee blades
	Squeegee out of adjustment	Adjust squeegee
	Clogged squeegee assembly	Clean squeegee assembly
	Vacuum hose loose	Secure vacuum hose connections
	Vacuum hose clogged	Flush vacuum hose
	Vacuum hose damaged	Replace vacuum hose
	Vacuum fan inlet filter dirty	Clean inlet filter
	Debris caught on squeegee	Remove debris from squeegee
	Vacuum hose to squeegee or recovery tank disconnected or damaged	Reconnect or replace vacuum hose
	Tank cover not completely closed	Check for obstructions
	Torn seals on recovery tank	Replace seals
Vacuum fan will not turn on	Recovery tank full	Drain recovery tank
	Foam filling recovery tank	Empty recovery tank
		Use less or change detergent
	Use a defoamer	
Little or no solution flow to the floor	Solution tank empty	Fill solution tank
	Solution flow turned off	Turn solution flow on
	Solution supply lines plugged	Flush solution supply lines
	Solution solenoid clogged or stuck	Clean or replace
Poor scrubbing performance	Debris caught on scrub brushes	Remove debris from brushes
	Improper detergent / brushes pads used	Contact Tennant representative for recommendations
	Worn scrub brushes pads	Replace scrub brushes / pads
	Excessive brush pressure	Reduce scrub brush down pressure
	Uneven brush pressure	Level scrub head
	Debris trough full	Empty debris trough
	Broken brush drive belts on cylindrical scrub head	Replace belts
	Low battery charge	Charge battery until the charger automatically turns off

OPERATION

Problem	Cause	Remedy
Reduced run time	Battery not fully charged	Charge battery until the charger automatically turns off
	Defective battery	Replace battery
	Batteries need maintenance	See BATTERIES in MAINTENANCE
	Faulty battery charger	Replace battery charger
ES System does not operate	<i>ES button</i> is turned off	Turn on <i>ES button</i>
	ES sensor in tank dirty or not in correct position	Clean / reposition sensor
	Clogged ES pump filter	Clean ES filter
	Water level in recovery tank too low	Fill recovery tank approximately half full
	Water level in solution tank too low	Fill solution tank
ec-H2O Model: Warning and fault indicator light blinking red	Mineral deposit build-up in module	Flush module (See <i>ec-H2O</i> MODULE FLUSH PROCEDURE)
ec-H2O Model: Warning and fault indicator light solid red	Clogged module	Contact Tennant service representative
	Defective solution pump	Replace solution pump
High pressure washer does not operate	Parking brake not set	Set parking brake
	Thermal switch tripped on high pressure pump motor	Let cool down
	Solution pump circuit tripped	Reset circuit breaker
	Switch was on when machine was started	Turn off / turn on switch
High pressure washer spraying low pressure	Spray nozzle set to low pressure	Adjust spray nozzle setting
	Spray pump pressure knob turned down	Adjust the spray pump pressure knob
Poor live wand vacuum performance	Clogged hose	Remove clog
	Torn seals on dry vacuum system	Replace seals

MAINTENANCE

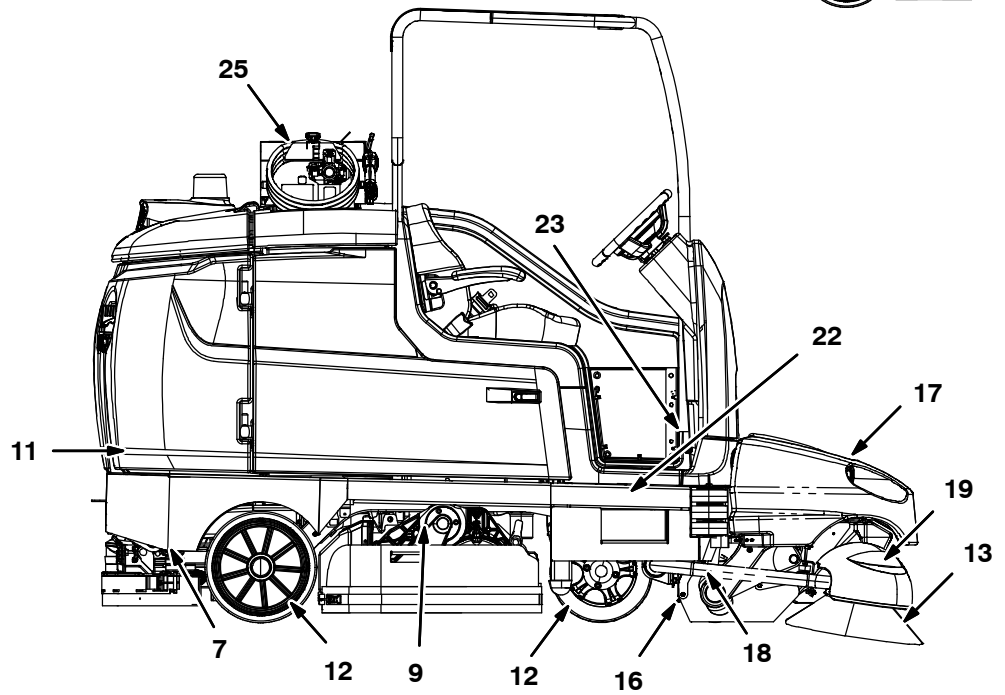
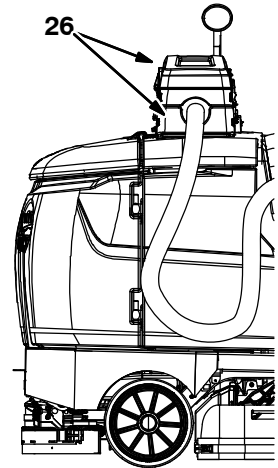
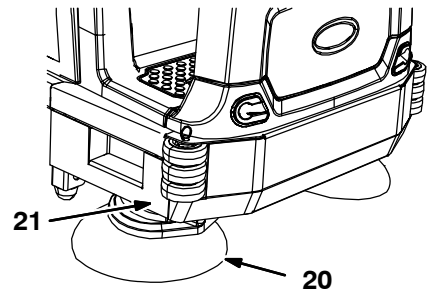
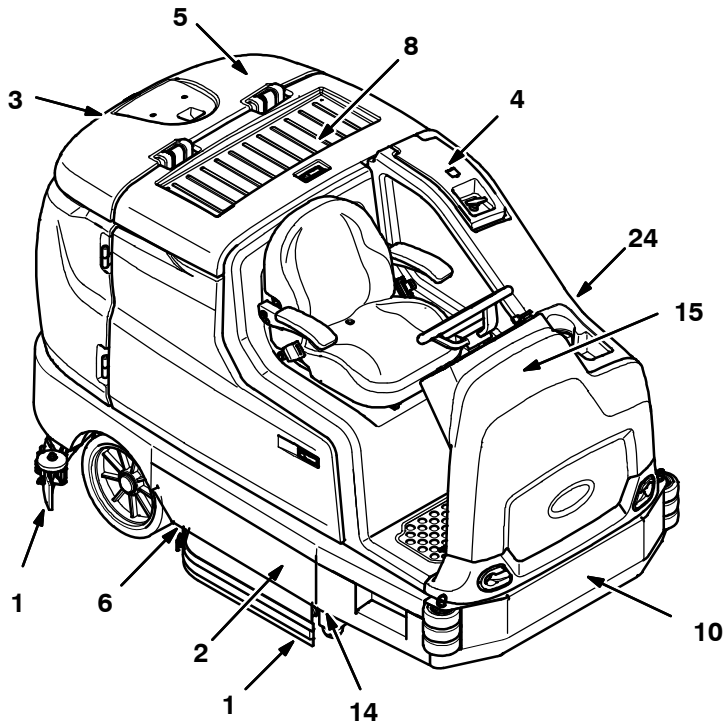

356389 356290

MAINTENANCE CHART

The table below indicates the *Person Responsible* for each procedure.

O = Operator.

T = Trained Personnel.

Interval	Person Resp.	Key	Description	Procedure	Lubricant/ Fluid	No. of Service Points
Daily	O	1	Side and rear squeegees	Check for damage and wear. Check deflection.	–	4
	O	2	Main brushes	Check for damage, wear, and debris	–	2
	O	3	Recovery tank	Clean tank, top sensor, and check cover seal	–	1
	O	4	Solution tank	Check cover seal	–	1
	O	3	ES machines only: Recovery tank	Clean filter at bottom of tank and second lower sensor.	–	2
	O	4	ES machines only: Solution tank	Clean tank and level sensor	–	1
	O	5	Vacuum fan inlet filter, screen, and debris tray	Clean	–	1
	O	6	Cylindrical brushes only: Debris tray	Clean	–	1
	O	20	Sweeping or scrubbing side brush (Option)	Check for damage, wear, debris	–	1 (2)
	O	20	Scrubbing side brush squeegee (Option)	Check for damage and wear	–	1
	O	13	Pre-Sweep side brushes (Option)	Check for damage, wear, debris	–	2
	O	16	Pre-Sweep main bush (Option)	Check for damage, wear, debris	–	1
	O	17	Pre-Sweep debris hopper (Option)	Clean	–	1
O	26	Live wand vacuum debris tray (Option)	Clean	–	1	
Weekly	T	8	Battery cells	Check electrolyte level	DW	Multiple
50 Hours	T	1	Side and rear squeegees	Check leveling	–	4
	O	16, 17	Pre-Sweep skirts and seals (Option)	Check for damage and wear	–	4
	O	2	Main brushes (cylindrical)	Rotate brushes from front to rear	–	2

LUBRICANT/FLUID

DW Distilled water.

SPL . . . Special lubricant, Lubriplate EMB grease (Tennant part number 01433-1)

GL SAE 90 weight gear lubricant

NOTE: More frequent maintenance intervals may be required in extremely dusty conditions.

MAINTENANCE

The table below indicates the *Person Responsible* for each procedure.

O = Operator.

T = Trained Personnel.

Interval	Person Resp.	Key	Description	Procedure	Lubricant/ Fluid	No. of Service Points
50 Hours	O	14	Scrub head skirts (disk)	Check skirts for damage and wear	–	2
	O	24	Solution supply filter	Check screen and clean	–	1
	T	25	High pressure washer (Option – only first 50 hours)	Change oil	Hydo	3
	O	26	Live wand vacuum seals (Option)	Check for damage and wear	–	3
100 Hours	T	8	Battery watering system (option)	Check hoses and connections for damage and wear	–	Multiple
200 Hours	T	23	Brakes	Check adjustments	–	1
	T	8	Battery terminals and cables	Check and clean	–	2
	T	9	Cylindrical brush drive belts	Check for damage and wear	–	2
	T	18	Pre–Sweep brush drive belt	Check for damage and wear	–	1
	T	22	Drive wheel pivot	Lubricate	SPL	1
	T	15	Steering chain	Lubricate, check tension, and check for damage and wear.	GL	1
	T	10	Steering gear chain	Lubricate, check tension, and check for damage and wear.	GL	1
500 Hours	T	11	Vacuum fan motors	Check motor brushes	–	2
	O	12	Tires	Check for damage and wear	–	3
800 Hours	T	22	Drive wheel motor	Change oil	Hydo	1
1000 Hours	T	21	Sweeping side brush motors	Check motor brushes (Check every 100 hours after initial 1000 hour check)	–	1 (2)
	T	18	Pre–Sweep main brush motor (Option)	Check motor brushes (Check every 100 hours after initial 1000 hour check)	–	1
	T	19	Pre–Sweep side brush motors (Option)	Check motor brushes (Check every 100 hours after initial 1000 hour check)	–	2

LUBRICANT/FLUID

DW Distilled water.

GL SAE 90 weight gear lubricant

GL SAE 90 weight gear lubricant

HYDO **Tennant True** premium hydraulic fluid or equivalent

NOTE: More frequent maintenance intervals may be required in extremely dusty conditions.

YELLOW TOUCH POINTS

This machine features easy to find yellow touch points for simple service items. No tools are required to perform these maintenance operations.

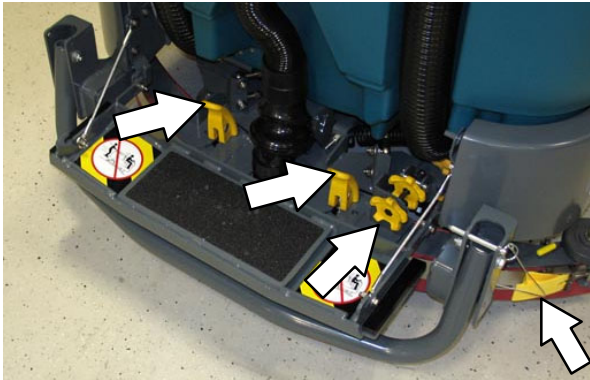
**LUBRICATION**

FOR SAFETY: Before leaving or servicing machine, stop on level surface, turn off machine, set parking brake, and remove key.

STEERING CHAIN

The steering chain is located on the steering column directly under the control panel. Check for damage or wear and lubricate the steering chain after every 200 hours.

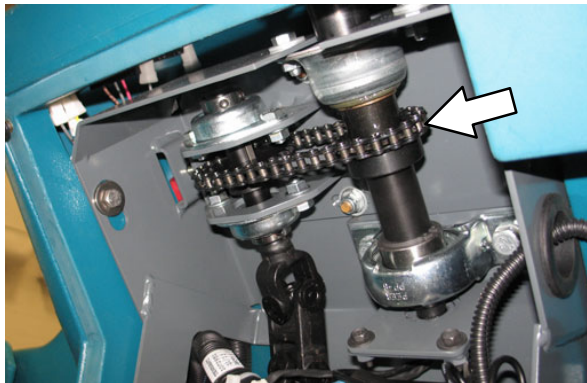
**STEERING GEAR CHAIN**

The steering gear chain is located directly above the front tire. Check for damage or wear and lubricate the steering gear chain after every 200 hours.

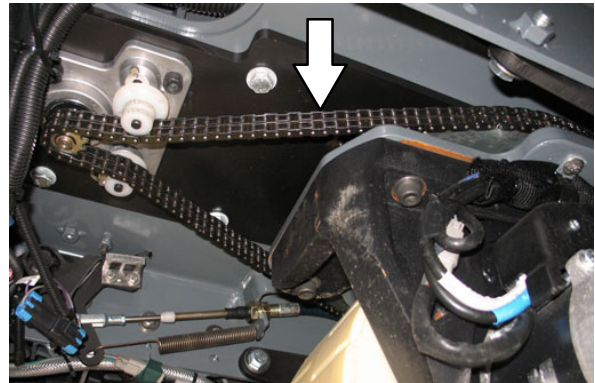
**DRIVE WHEEL PIVOT**

The drive wheel pivot is located directly above the drive wheel. Lubricate the drive wheel pivot after every 200 hours.

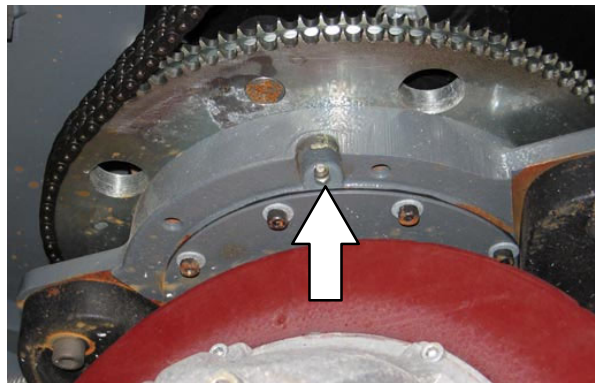
**DRIVE WHEEL MOTOR**

The drive wheel motor has an oil drain plug under the motor. Replace the oil after every 800 hours of operation.



MAINTENANCE

HIGH PRESSURE WASHER OIL

Change the high pressure washer oil after the initial 50 hours of high pressure washer operation.

NOTE: Remove high pressure washer cover to access both the high pressure washer drain plug and vented fill cap.

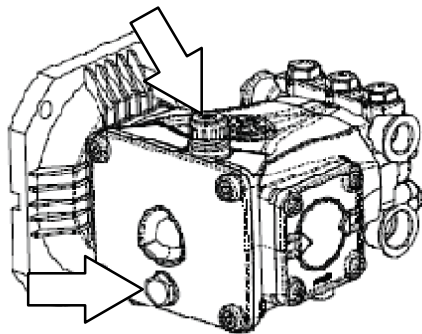
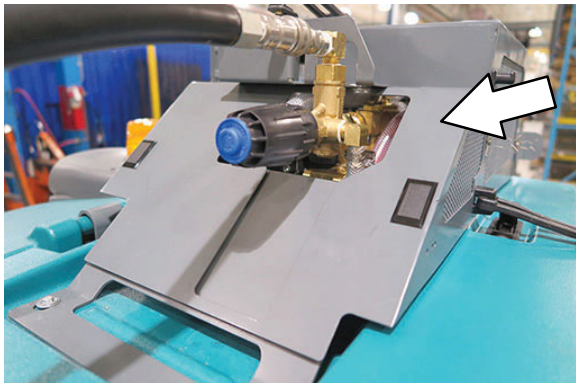

BATTERIES

FOR SAFETY: Before leaving or servicing machine, stop on level surface, turn off machine, set parking brake (if equipped), and remove key.

The lifetime of the batteries depends on their proper maintenance. To get the most life from the batteries;

- Do not charge the batteries more than once a day and only after running the machine for a minimum of 15 minutes.
- Do not leave the batteries partially discharged for long period of time.
- Only charge the batteries in a well-ventilated area to prevent gas build up. Charge batteries in areas with ambient temperatures 27°C (80°F) or less.
- Allow the charger to complete charging the batteries before re-using the machine.
- Maintain the proper electrolyte levels of flooded (wet) batteries by checking levels weekly.

CHECKING THE ELECTROLYTE LEVEL

The flooded (wet) lead-acid batteries require routine maintenance as described below. Check the battery electrolyte level weekly.

NOTE: Do Not check the electrolyte level if the machine is equipped with the battery watering system. Proceed to the BATTERY WATERING SYSTEM (OPTION).

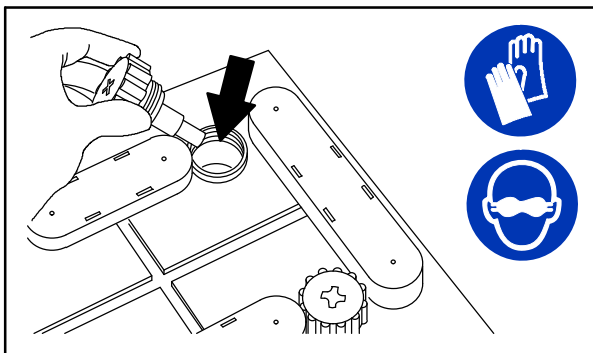

08247

FOR SAFETY: When servicing machine, keep all metal objects off batteries. Avoid contact with battery acid.

The level should be slightly above the battery plates as shown before charging. Add distilled water if low. **DO NOT OVERFILL.** The electrolyte will expand and may overflow when charging. After charging, distilled water can be added up to about 3 mm (0.12 in) below the sight tubes.

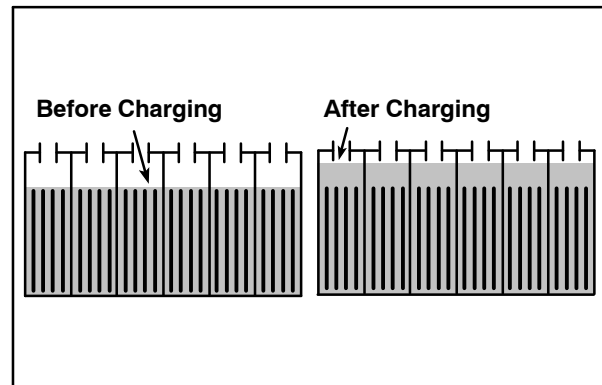

NOTE: Make sure the battery caps are in place while charging. There may be a sulfur smell after charging batteries. This is normal.

MAINTENANCE-FREE BATTERIES

Maintenance-free batteries do not require watering. Cleaning and other routine maintenance is still required.

CHECKING CONNECTIONS / CLEANING

After every 200 hours of use check for loose battery connections and clean the surface of the batteries, including terminals and cable clamps, with a strong solution of baking soda and water. Replace any worn or damaged wires. Do not remove battery caps when cleaning batteries.



MAINTENANCE

CHARGING THE BATTERIES

IMPORTANT: Before charging, make sure that the charger setting is properly set for the battery type.

NOTE: Use a charger with the proper rating for the batteries to prevent damage to the batteries or reduce the battery life.

1. Drive the machine to a flat, dry surface in a well-ventilated area.
2. Stop the machine and turn off the machine power.

FOR SAFETY: Before leaving or servicing machine, stop on level surface, turn off machine, set parking brake, and remove key.

3. Lift the battery compartment top cover open and engage the support.

NOTE: Make sure the batteries have the proper electrolyte level before charging. See **CHECKING THE ELECTROLYTE LEVEL**.

4. Plug the charger AC power supply cord into a properly grounded outlet.
5. Disconnect the battery side cable connector from the machine by pulling down on the connector or the battery quick-disconnect lever (option). Do not pull on the cables.

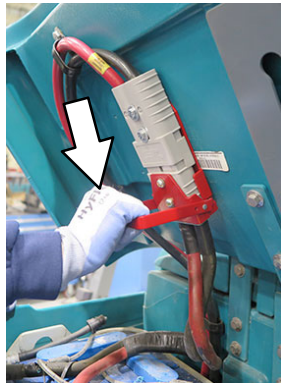
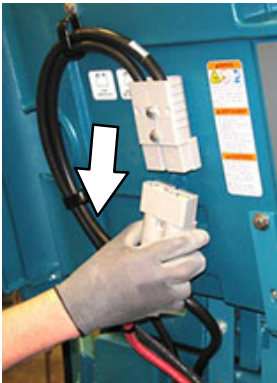

6. Connect the charger connector to the battery cable.

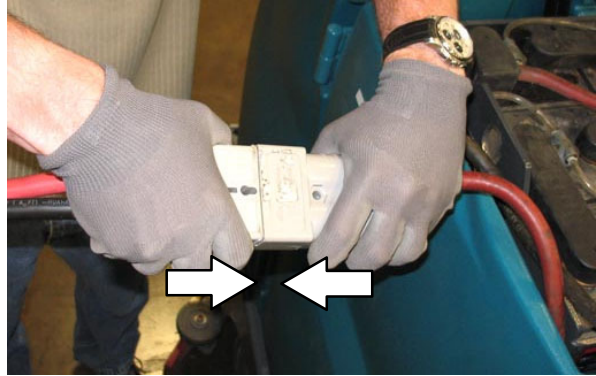

7. Turn on the battery charger if required.

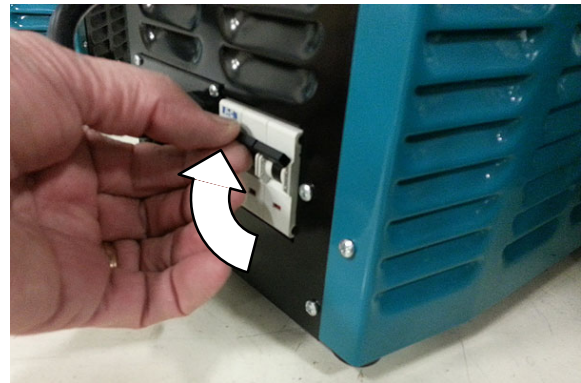

WARNING: Batteries emit hydrogen gas. Explosion or fire can result. Keep sparks and open flame away. Keep covers open when charging.

NOTE: If there are charger fault codes when the battery is plugged into the battery charger, the fault codes will appear at the bottom of the charger display. Refer to the battery charger manual for fault code definitions.



- Observe the charger display. CHARGE appears on the display when the battery is charging. This is the charger default screen.

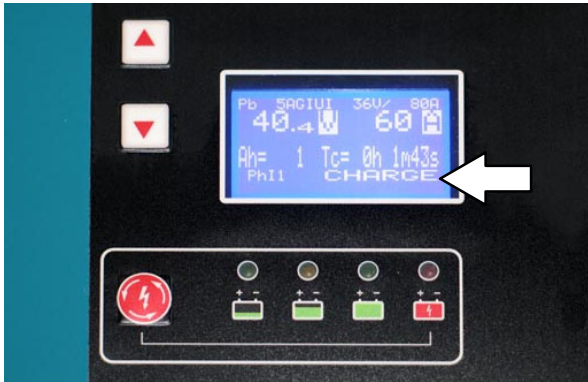

Charger Display:

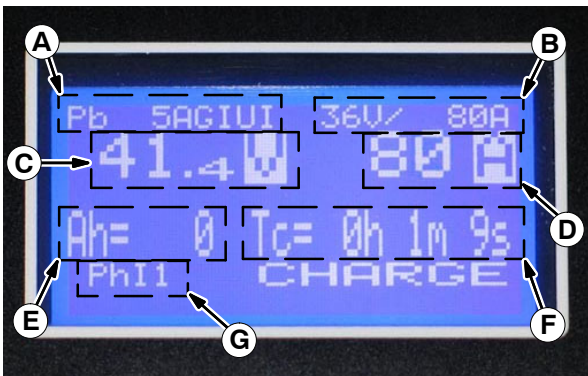

- Charge profile number
- Charger rating (Volts and Current)
- Battery voltage (Volts)
- Charger current (Amperes)
- Ampere hours charged
- Time charged (hours / minutes / seconds)
- Charging phase (Phase 1 / Phase 2 / Phase 3 / Maintenance)

- If necessary, press the navigation buttons to access additional screens. Press the charger stop / start / enter button to enter selection. The charger will return to the default screen. Refer to manufacturers operator manual for additional information.



NOTE: If the charger cable must be disconnected from the battery before they are fully charged, press the charger stop / start / enter button to stop charging. Be sure STOP appears on the display and the red stop charge light is illuminated before disconnecting the battery charger cable.

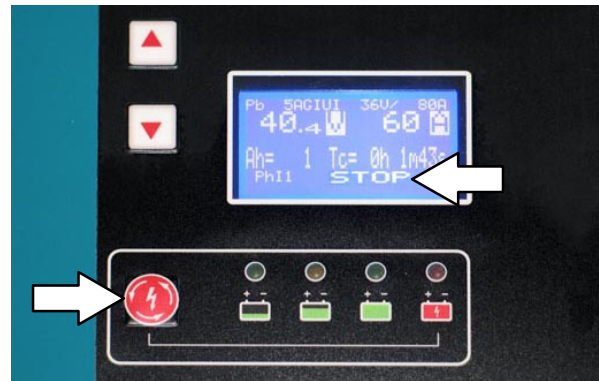

- The charger status indicators will illuminate from left to the right as the battery is charging. COMPLETE will appear in the display, all the charger status indicators will be illuminated, and the Tennant charger will stop charging when the battery is completely charged.

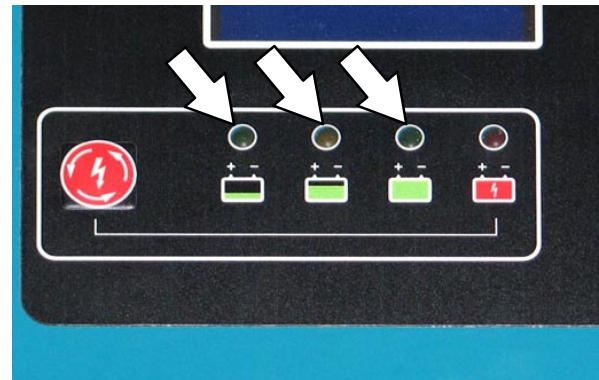

MAINTENANCE

11. After the batteries have completely charged, disconnect the charger connector from the battery cable connector.

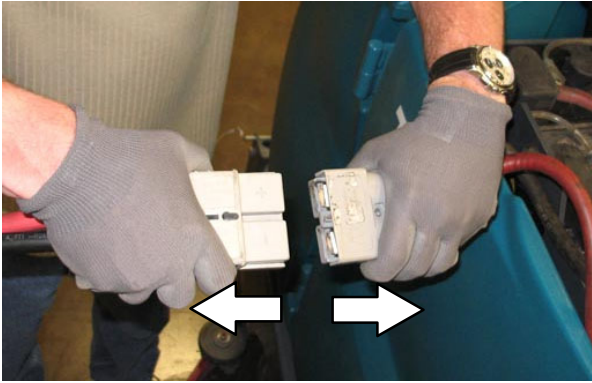

12. Reconnect the battery connector to the machine connector.

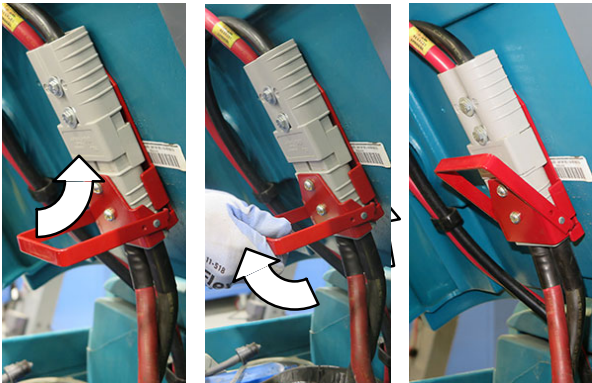
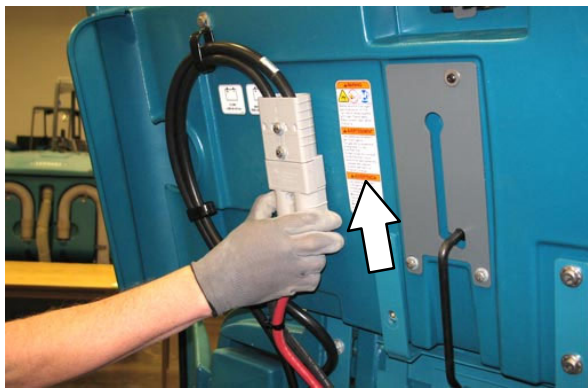

FOR SAFETY: When servicing machine do not disconnect the off-board charger's DC cord from the machine receptacle when the charger is operating. Arcing may result. If the charger must be interrupted during charging, disconnect the AC power supply cord first.

13. Close the battery compartment top cover.

FOR SAFETY: Before leaving or servicing machine, stop on level surface, turn off machine, set parking brake, and remove key.

BATTERY CHARGER USB PORT

The battery charger USB port is for maintenance computer access to the charger by authorized service personnel only. **Do Not** plug cell phones or other unauthorized electronic devices into the battery charger USB port. **Do Not** plug anything into the USB port while the battery is charging.

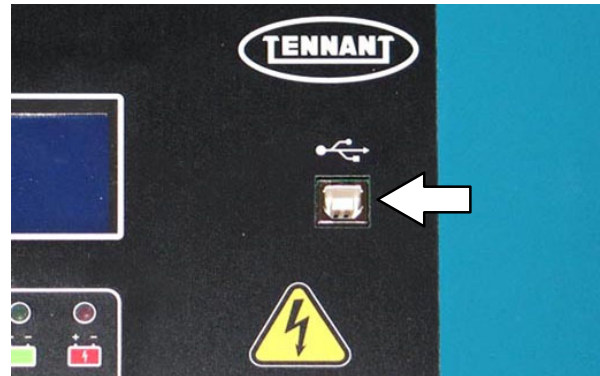

BATTERY WATERING SYSTEM (OPTION)

The optional battery watering system provides a safe and easy way to maintain the proper electrolyte levels in the batteries.

Check the battery watering system hoses and connections for damage or wear after every 100 hours.

FOR SAFETY: Before leaving or servicing machine, stop on level surface, turn off machine, set parking brake, and remove key.

1. Lift the battery compartment cover open and engage the support.

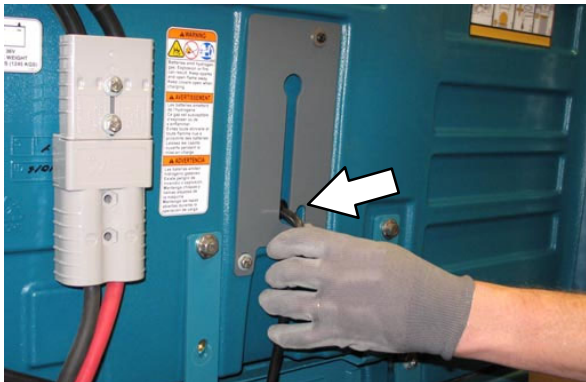

2. Fully charge batteries prior to using the battery watering system. Do not add water to batteries before charging, the electrolyte level will expand and may overflow when charging. See *CHARGING THE BATTERIES*.
3. Connect the battery watering system hose to the water supply source.

NOTE: Water quality is important to maintain the life of the battery. Always use water that meets battery manufacturer requirements.

NOTE: The water supply to the battery water system must always be 7.57 LPM (2 GPM) or more. Use the purger to confirm the water supply pressure. Refer to manufacturer Operator Manual for additional information.

4. Connect the battery watering system hose to the battery fill hose.

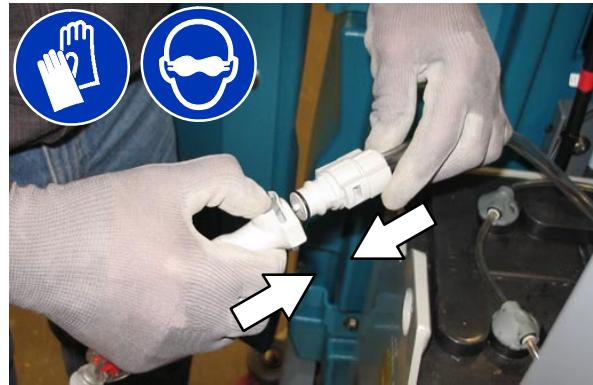

5. Turn on the water supply. The indicator inside the flow indicator will spin. The indicator stops spinning when the batteries are full.

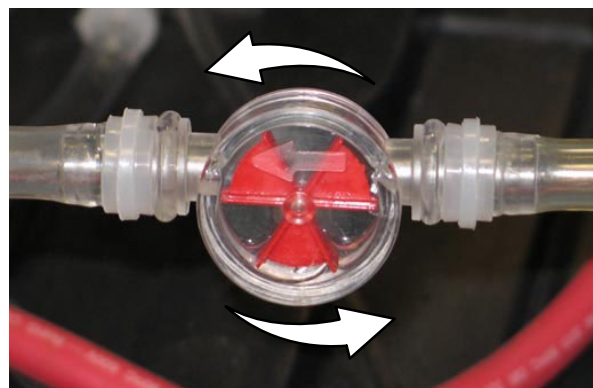

6. Disconnect the battery watering system hose from the water supply hose.
7. Turn off the water supply.
8. After adding water, return the battery watering system hose to the storage location for future use.

CIRCUIT BREAKERS, FUSES, AND RELAYS

CIRCUIT BREAKERS

Circuit breakers are resettable electrical circuit protection devices designed to stop the flow of current in the event of a circuit overload. Once a circuit breaker is tripped, reset it manually by pressing the reset button after the breaker has cooled down.

Circuit breakers 1 through 9 are located under the operator seat behind the battery compartment side cover.



Circuit breakers 10 through 15 are located behind the steering shroud access panel.

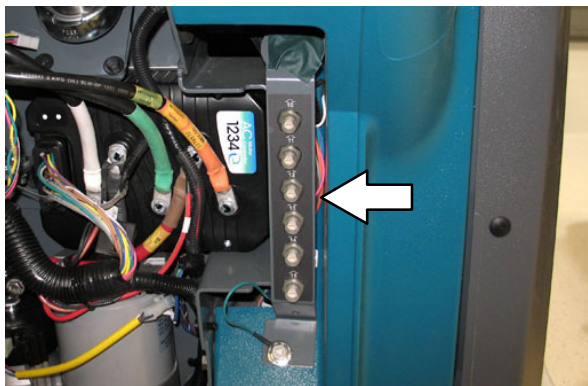

Circuit breaker 16 is located inside the optional light assembly mounted on top of the recovery tank.

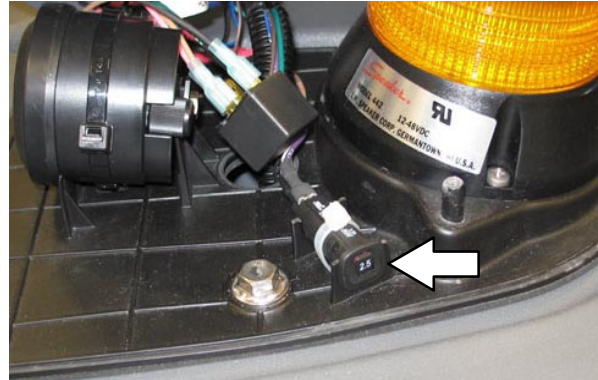

If the overload that caused the circuit breaker to trip is still present, the circuit breaker will continue to stop current flow until the problem is corrected.

The chart below shows the circuit breakers and the electrical components they protect.

Circuit Breaker	Rating	Circuit Protected
CB1	60 A	Water pickup module
CB2	50 A	Pre-Sweep module (Option)
CB3A	20 A	Side brush sweep module (Option)
CB3B	35 A	Side brush scrub module (Option)
CB4	2.5 A	Key switch
CB5	2.5 A	Water pick up module
CB6	2.5 A	Scrub module
CB7A	-	Not Used
CB7B	2.5 A	Pre-Sweep module (Option)
CB7C	2.5 A	Side brush scrub module (Option)
CB8	2.5 A	<i>ec-H2O</i> module
CB9	2.5 A	<i>ec-H2O</i> pump
CB10	15 A	Spray nozzle (Option) / High Pressure washer (Option)
CB11	15 A	Lights (Option)
CB12	2.5 A	Headlights (Option)
CB13	2.5 A	Strobe light / Flashing light on over head guard (Option)
CB14	2.5 A	Strobe light / Flashing light on recovery tank cover (Option)
CB15	15 A	Power steering (Option)
CB16	2.5 A	Backup alarm / light (Option)

FUSES

Fuses are one-time protection devices designed to stop the flow of current in the event of a circuit overload. Never substitute higher value fuses than specified.

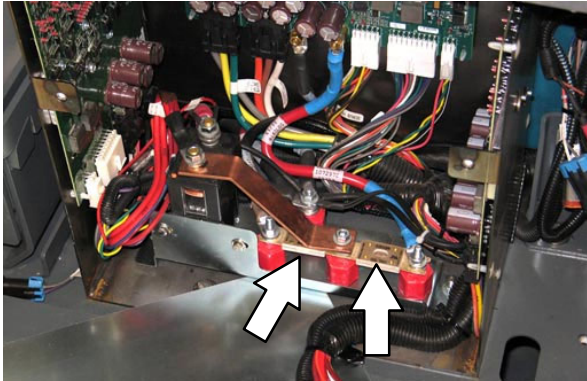

The fuses are located in the control box behind the circuit breaker panel.

Fuse	Rating	Circuit Protected
FU-1	150 A	Propelling
FU-2	100 A	Scrub module power
FU-3	2.0 A	Telemetry module harness
Inline fuse	100 A	High pressure washer (Option)
Inline fuse	40 A	Live wand (Option)

RELAYS

Relays are electrical switches that open and close under the control of another electrical circuit. Relays are able to control an output circuit of higher power than the input circuit. The relays are located in the control box behind the circuit breaker panel.

Refer to the table below for the *relays* and circuits controlled.

Relay	Rating	Circuit Controlled
M1	36 VDC, 200 A	Main contactor
M2	36 VDC, 5 A	Backup alarm / light (Option)
M3	36 VDC, 100 A	Auxiliary line contactor

ELECTRIC MOTORS

Inspect the carbon brushes on the vacuum fan motor after every 500 hours of operation. Inspect the carbon brushes on the sweeping side brush motors and all Pre-Sweep motors after the first 1000 hours of operation and every 100 hours after the initial check. Refer to the table below for carbon brush inspection intervals.

Carbon Brush Inspection	Hours
Side brush motors – Sweeping (Option)	1000*
Pre-Sweep motors (Option)	1000*
Vacuum motor	500
High pressure washer motor (Option)	1000**

**Inspect carbon brushes every 100 hours after the initial 1000 hour change.*

***Inspect after 1000 high pressure washer hours, not machine hours.*

SOLUTION SUPPLY FILTER

Check the solution supply filter screen after every 50 hours of operation and clean if necessary. Lower the scrub head for easier access.

FOR SAFETY: Before leaving or servicing machine, stop on level surface, turn off machine, set parking brake, and remove key.

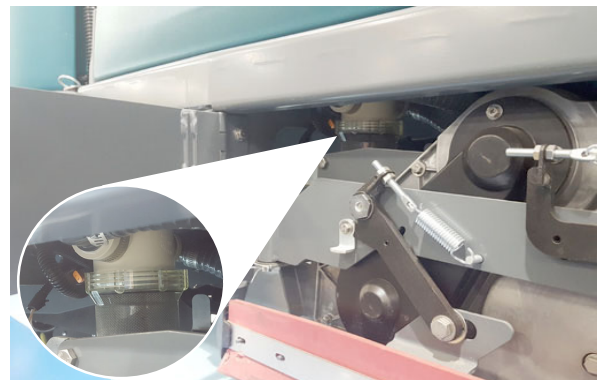

SCRUB BRUSHES

The machine can be equipped with either *disk* or *cylindrical* scrub brushes. Check scrub brushes daily for wire or string tangled around the brush or brush drive hub. Also check brushes or pads for damage and wear.

DISK BRUSHES AND PADS

Replace the pads when they no longer clean effectively. Replace the brushes when they no longer clean effectively or when the bristles are worn to the yellow indicator.

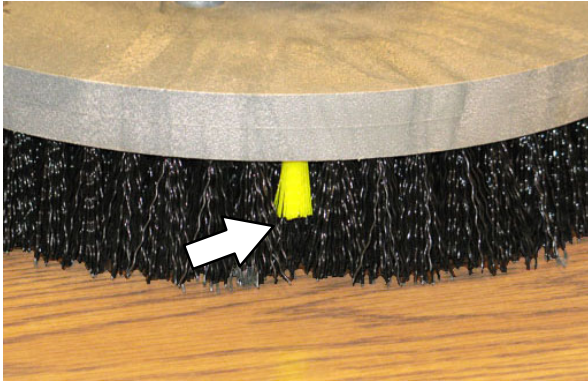

Cleaning pads must be placed on pad drivers before they are ready to use. The cleaning pad is held in place with a center disk. Both sides of the pad can be used for scrubbing. Turn the pad over to use the other side.

Cleaning pads need to be cleaned immediately after use with soap and water. Do not wash the pads with a pressure washer. Hang pads, or lay pads flat to dry.

NOTE: Always replace brushes and pads in sets. Otherwise one brush or pad will be more aggressive than the other.

REPLACING DISK BRUSHES OR PAD DRIVERS

1. Raise the scrub head.
2. Turn off the machine.

FOR SAFETY: Before leaving or servicing machine, stop on level surface, turn off machine, set parking brake, and remove key.

3. Open the main brush access door and side squeegee support door.

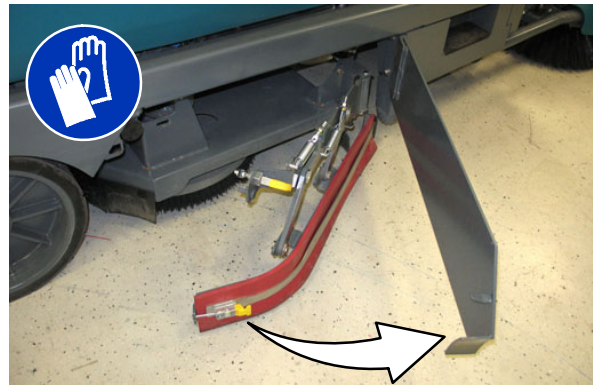

4. Turn the brush until the spring handles are visible.

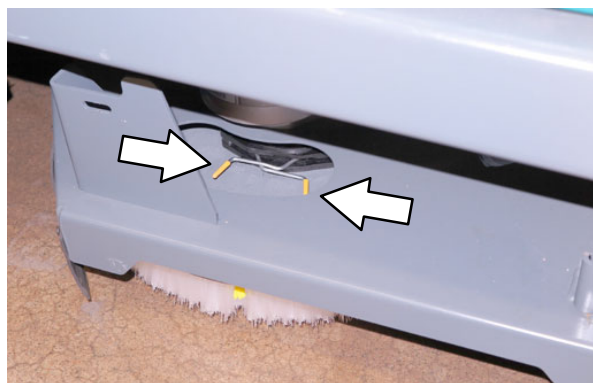

5. Squeeze the spring handles and let the brush drop to the floor. Remove the brush from under the scrub head.



- Set the brush spring open on the new brush to make installation easier.

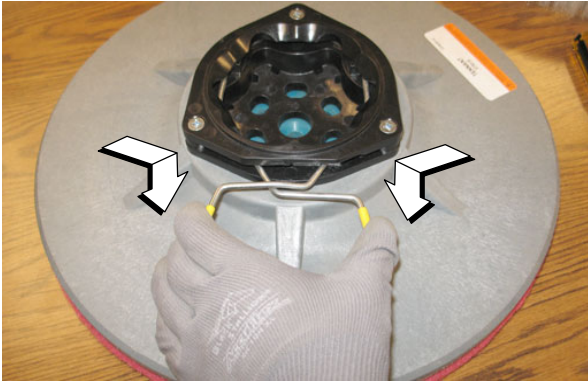

- Push the new brush under the scrub head, align the brush drive socket with the brush drive hub, and lift the brush up onto the brush drive hub until the brush locks onto the hub.



- Ensure the brush is securely mounted on the brush drive hub.
- Close and secure the squeegee support door and close the main brush access door.
- Repeat procedure for the other brushes.

REPLACING DISK SCRUB PADS

- Remove the pad driver from the machine.
- Squeeze the spring clip together and remove the center disk from the pad driver.



- Remove the scrub pad from the pad driver.



- Flip or replace the scrub pad. Center the scrub pad on the pad driver and reinstall the center disk to secure the pad in place on the pad driver.
- Reinstall the pad driver onto the machine.

MAINTENANCE

CYLINDRICAL BRUSHES

Rotate the brushes from front-to-rear after every 50 hours of operation.

Replace the brushes when they no longer clean effectively.

NOTE: Replace worn brushes in pairs. Scrubbing with brushes of unequal bristle length will result in diminished scrubbing performance.

REPLACING CYLINDRICAL SCRUB BRUSHES

FOR SAFETY: Before leaving or servicing machine, stop on level surface, turn off machine, set parking brake, and remove key.

1. Open the main brush access door and side squeegee support door.

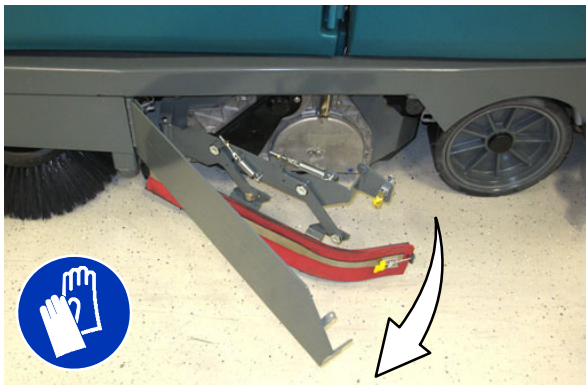

2. Lift the idler plate retainer handle and unhook the retainer ring from the idler plate hook.

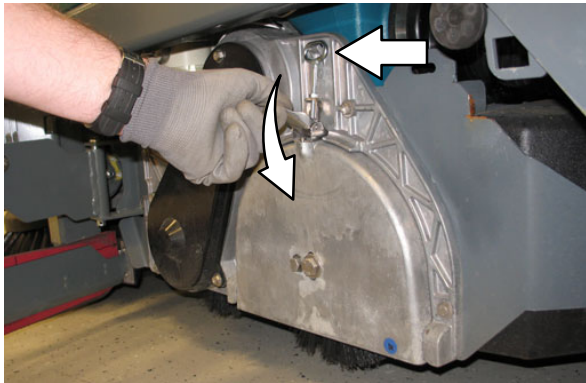

3. Remove the idler plate from the scrub head.



4. Remove the brush from the scrub head

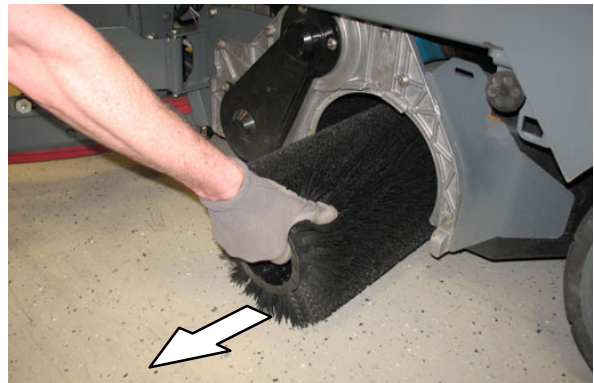

5. Position the brush with the *double row end* towards the scrub head opening. Guide the new brush onto the drive hub.

6. If rotating the brushes, always rotate the front with the back so that they wear evenly. They may be rotated end for end as well.

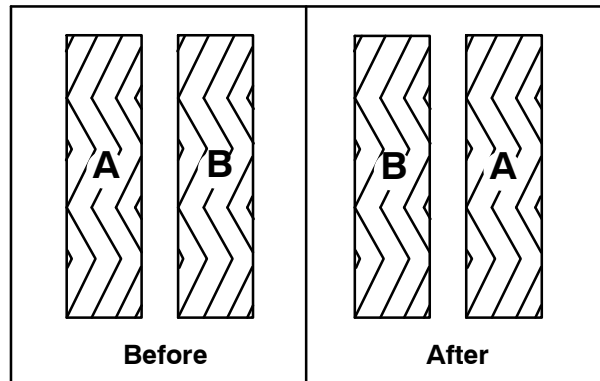

7. Slide the idler plate up into the scrub head.



8. Secure the idler plate into place with the idler plate retainer.

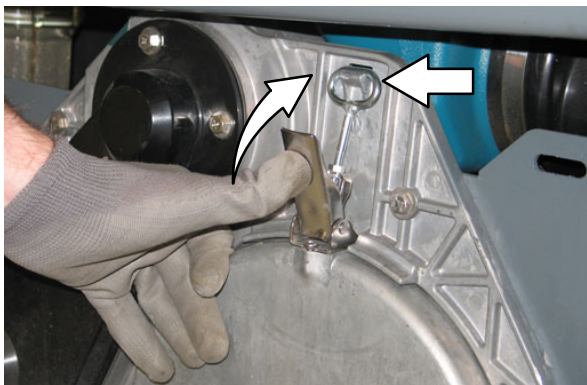

NOTE: Do not switch the left or right idler plates or the brushes will need to be readjusted by trained personnel.

9. Close and secure the squeegee support door and close the main brush access door.
10. Repeat for the brush on the other side of the scrub head.

MAINTENANCE

SIDE BRUSH(ES) (OPTION)

Check the side brushes daily for wear or damage. Remove any tangled string or wire from the side brushes or side brush drive hubs.

REPLACING THE SCRUBBING SIDE BRUSH

Replace the pads when they no longer clean effectively. Replace the brushes when they no longer clean effectively or when the bristles are worn down to the yellow indicators.

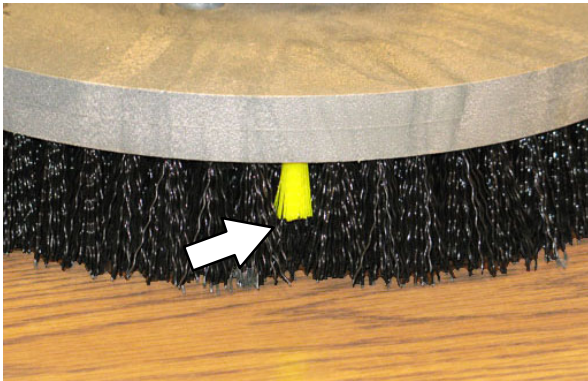

1. Raise the side brush assembly and turn off the machine.

FOR SAFETY: Before leaving or servicing machine, stop on level surface, turn off machine, set parking brake, and remove key.

2. Squeeze the spring handles and let the side brush drop to the floor.



3. Remove the side brush from under the side brush assembly.



4. Set the brush spring open on the new brush to make installation easier.



5. Place the new side brush underneath the side brush assembly and lift the side brush up onto the side brush hub until the brush locks onto the hub.

REPLACING THE SWEEPING SIDE BRUSH(ES)

Replace the brushes when they no longer clean effectively.

1. Raise the side brush assembly and turn off the machine.

FOR SAFETY: Before leaving or servicing machine, stop on level surface, turn off machine, set parking brake, and remove key.

2. Reach into the center of the brush and remove the cotter pin holding the brush and the retaining washer to the hub.



3. Remove the side brush and retaining washer from under the side brush assembly.



4. Place the new side brush underneath the side brush and align the channel in the side brush receptacle with the two brush locks on the side brush hub.

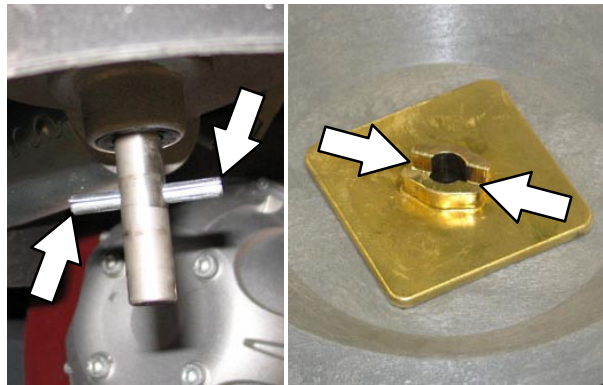

5. Lift the side brush up onto the side brush hub, hold the side brush onto the hub, install the retaining washer onto the hub, and reinstall the cotter pin into the hub.

PRE-SWEEP BRUSHES (OPTIONAL)

The Pre-Sweep assembly is equipped with *disk* side brushes and a *cylindrical* main brush. Check the brushes daily for wire or string tangled around the brush or brush drive hub. Check the brushes daily for damage and wear.

REPLACING THE PRE-SWEEP SIDE BRUSHES

Replace the brushes when they no longer clean effectively.

1. Turn on the machine.
2. Press the Pre-Sweep switch to raise the Pre-Sweep assembly and stop sweeping.

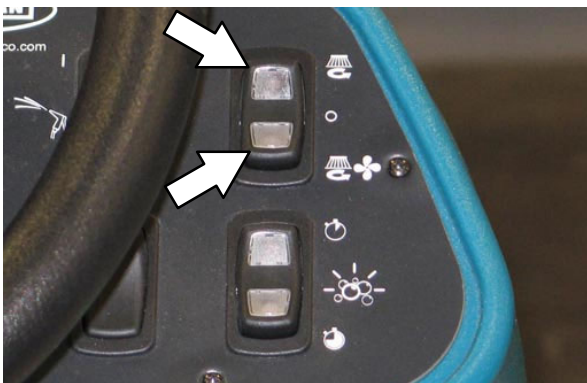

3. Turn off the machine.

FOR SAFETY: Before leaving or servicing machine, stop on level surface, turn off machine, set parking brake, and remove key.

4. Reach into the center of the brush and remove the cotter pin holding the brush and the retaining washer to the hub.



5. Remove the side brush and retaining washer from under the Pre-Sweep assembly.



6. Place the new side brush underneath the side brush and align the channel in the side brush receptacle with the two brush locks on the side brush hub.

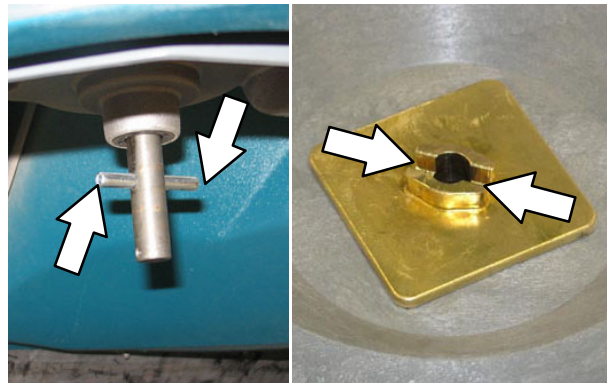

7. Lift the side brush up onto the side brush hub, hold the side brush onto the hub, install the retaining washer onto the hub, and reinstall the cotter pin into the hub.

REPLACING THE PRE-SWEEP CYLINDRICAL BRUSH

Rotate the brushes from front-to-rear after every 50 hours of operation.

Replace the brush when it no longer cleans effectively.

FOR SAFETY: Before leaving or servicing machine, stop on level surface, turn off machine, set parking brake, and remove key.

1. Turn off the machine.
2. Loosen both Pre-Sweep cover latches.



3. Lift the Pre-Sweep cover, lock the cover open, and engage the Pre-Sweep cover support.



4. Loosen and remove the left brush arm knob.



5. Remove the left brush arm.



6. Remove the three knobs holding the Pre-Sweep side skirt and side skirt plate to the Pre-Sweep assembly.

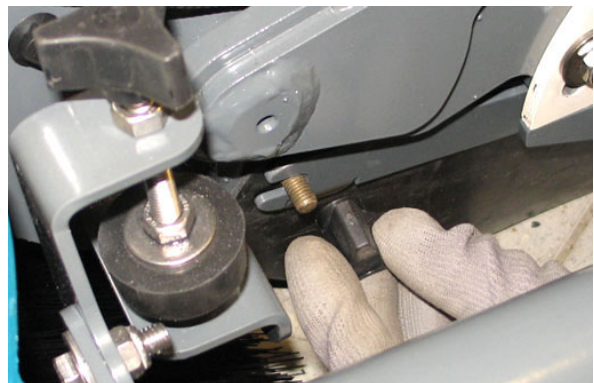

MAINTENANCE

7. Remove the side skirt plate and side skirt from the Pre-Sweep assembly.



8. Remove the cylindrical brush and replace with a new brush.



9. Guide the slotted end of the new brush onto the drive hub.
10. Reinstall the side skirt, side skirt plate, and left brush arm.

SQUEEGEE BLADES

Check the squeegee blades for damage and wear daily. When the blades become worn, rotate the blades end-for-end or top-to-bottom to a new wiping edge. Replace blades when all edges are worn.

Check the deflection of the squeegee blades daily or when scrubbing a different type of surface. Check the leveling of the rear squeegee every 50 hours of operation.

REPLACING (OR ROTATING) THE REAR SQUEEGEE BLADES

1. If necessary, lower the *Rear bumper door / step*.

FOR SAFETY: Before leaving or servicing machine, stop on level surface, turn off machine, set parking brake, and remove key.

2. Disconnect the vacuum hose from the rear squeegee assembly.

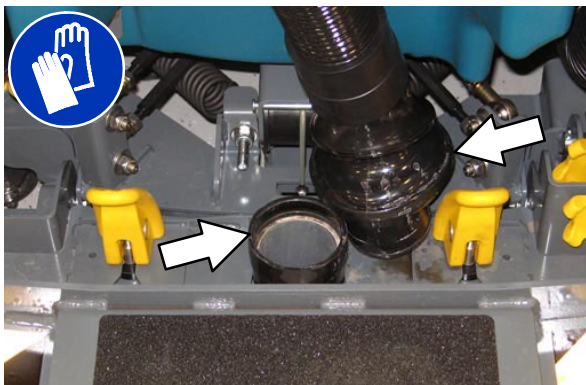

3. Loosen both squeegee mounting handles.

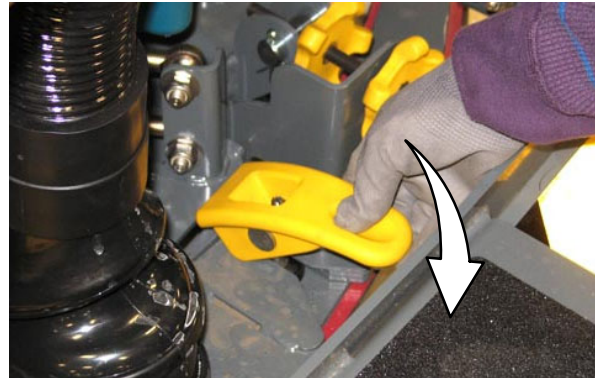
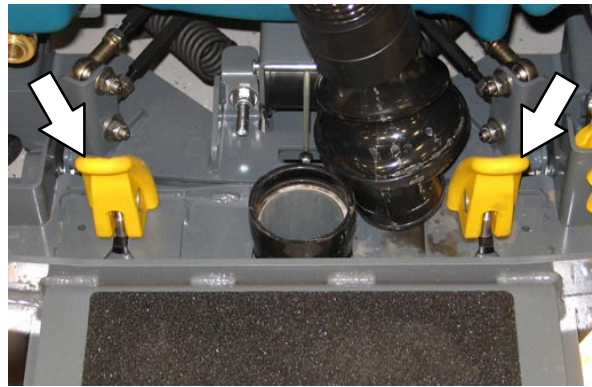

4. Pull the rear squeegee assembly from the machine.



MAINTENANCE

5. Loosen the rear retainer latch and remove the latch and the retainer from the squeegee assembly.

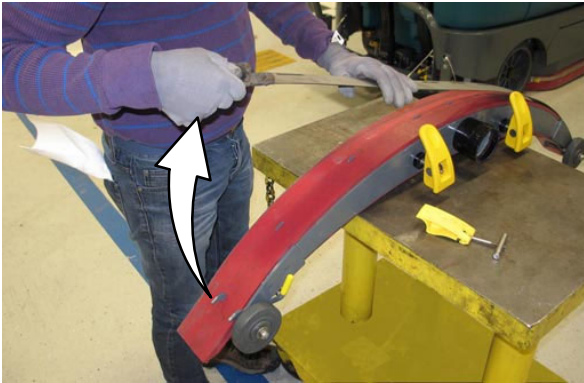

6. Remove the rear squeegee from the squeegee assembly.

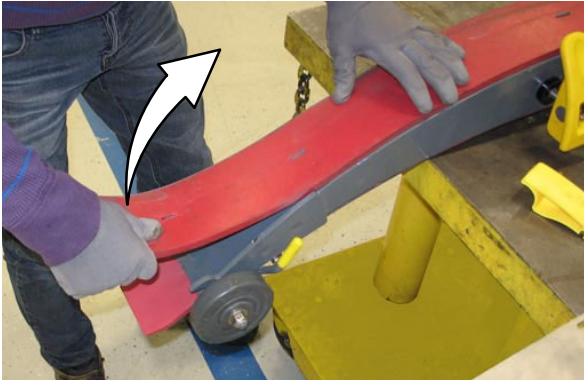

7. Place the rotated or new squeegee blade onto the rear squeegee assembly. Be sure the squeegee is securely attached on each tab on the rear squeegee assembly.



8. Insert the hinge end of the retainer into the hooks in the rear squeegee assembly.

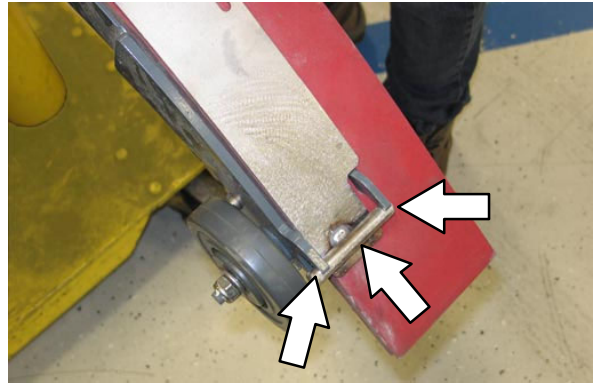

9. Install the retainer along the rest of the squeegee assembly, align the tabs on the squeegee assembly into the slots in the retainer, and tighten the latch onto the other end of the squeegee assembly.

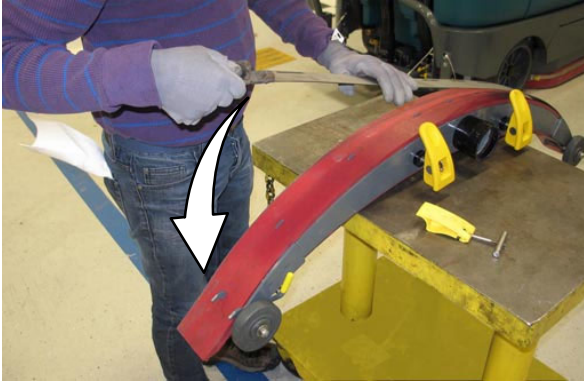

10. Turn the rear squeegee assembly over to access the front of the squeegee assembly.

11. Loosen the front retainer latch and remove the latch and the retainer from the squeegee assembly.

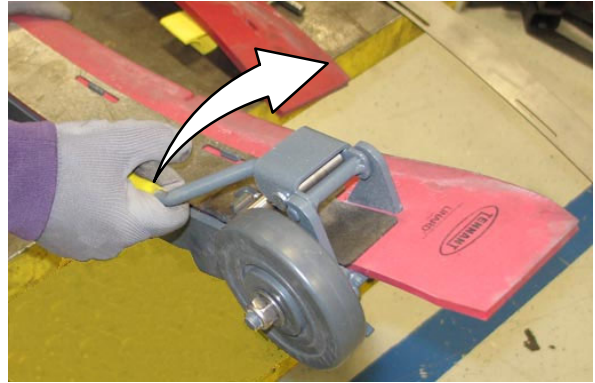

12. Remove the front squeegee from the squeegee assembly



MAINTENANCE

13. Install the rotated or new squeegee blade onto the squeegee assembly. Be sure the holes in the squeegee blade are hooked onto the tabs.

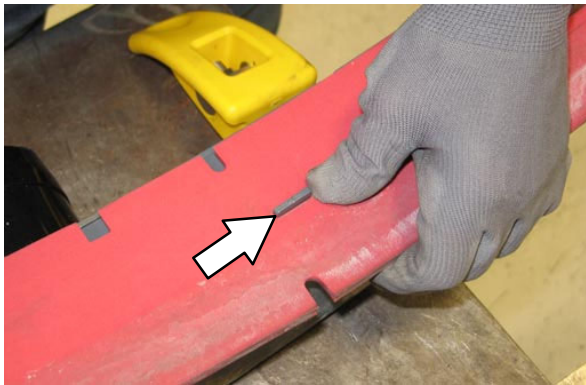

14. Install the front squeegee retainer onto the rear squeegee assembly.



15. Reinstall the rear squeegee assembly onto the machine
16. Raise the *Rear bumper door / step* if it was lowered to access the rear squeegee assembly.

LEVELING THE REAR SQUEEGEE

Leveling the squeegee ensures the entire length of the squeegee blade is in even contact with the surface being scrubbed. Perform this adjustment on an even and level floor.

1. Lower the squeegee and drive the machine several meters (feet) forward and slowly bring the machine to a stop.
2. Check the squeegee deflection over the full length of the squeegee blade.

FOR SAFETY: Before leaving or servicing machine, stop on level surface, turn off machine, set parking brake, and remove key.

3. Lower the *Rear bumper door / step*.
4. If the deflection is not the same over the full length of the blade, use the tilt adjust knob to make adjustments.

DO NOT disconnect the vacuum hose from the squeegee frame when leveling squeegee.

5. To adjust the squeegee leveling, loosen the tilt lock knob.

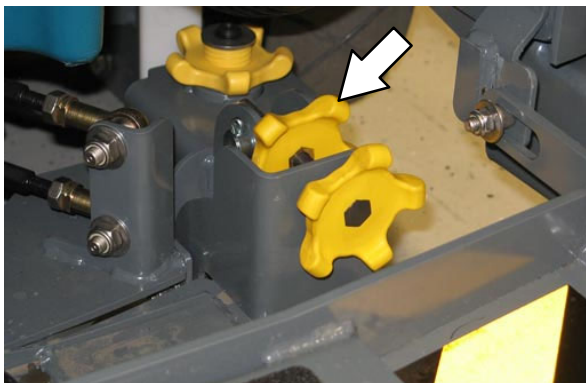

6. Turn the squeegee tilt adjust knob counter-clockwise to decrease the deflection at the ends of the squeegee blade.

Turn the squeegee tilt adjust knob clockwise to increase the deflection at the ends of the squeegee blade.

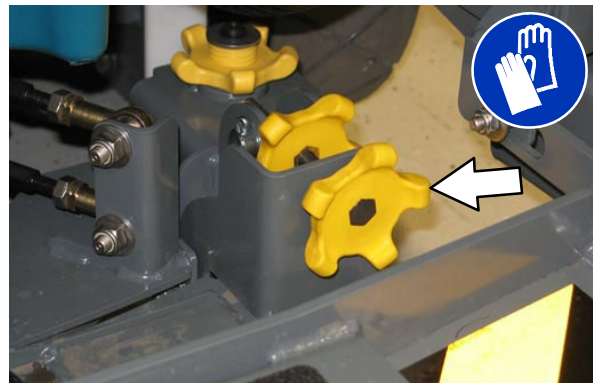

7. Tighten the tilt lock knob.
8. Drive the machine forward with the squeegee down to recheck the squeegee blade deflection if adjustments were made.
9. Readjust the squeegee blade deflection if necessary.
10. Raise the *Rear bumper door / step* when finished leveling the rear squeegee.

ADJUSTING THE REAR SQUEEGEE BLADE DEFLECTION

Deflection is the amount of curl the overall squeegee blade has when the machine moves forward. The best deflection is when the squeegee wipes the floor dry with a minimal amount of deflection.

NOTE: Make sure the squeegee is level before adjusting the deflection. See LEVELING THE REAR SQUEEGEE.

1. Lower the squeegee and drive the machine several meters (feet) forward and slowly bring the machine to a stop.

FOR SAFETY: Before leaving or servicing machine, stop on level surface, turn off machine, set parking brake, and remove key.

2. Look at the amount of deflection or “curl” of the squeegee blade. The correct amount of deflection is 12 mm (0.50 in) for scrubbing smooth floors and 15 mm (0.62 in) for rough floors.

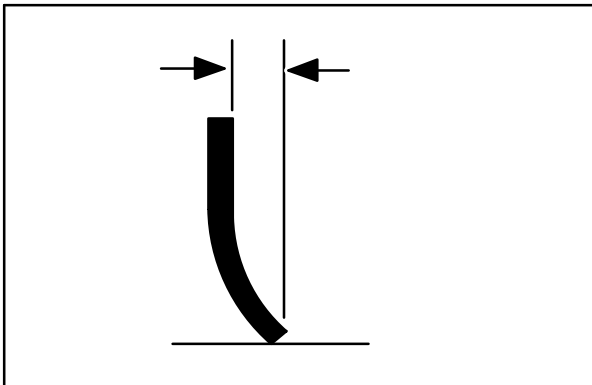

3. Lower the *Rear bumper door / step*.

4. To adjust the overall squeegee blade deflection, loosen the lock knobs on both sides of the machine.

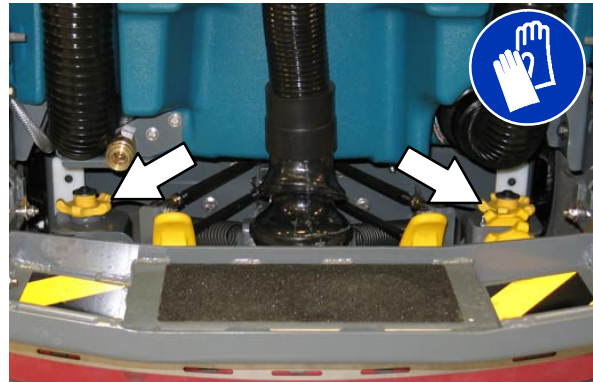

5. Turn the adjustment knobs clockwise to increase deflection or counterclockwise to decrease deflection.

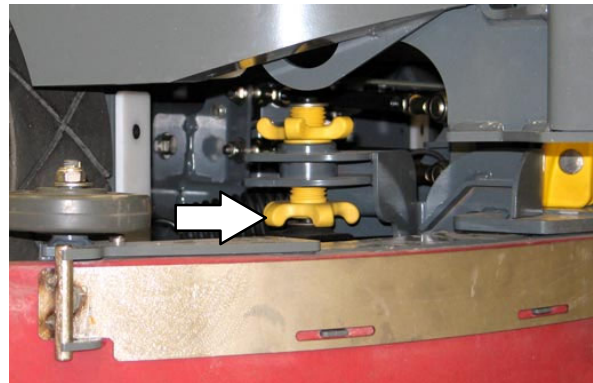

6. Retighten the lock knobs.
7. Drive the machine forward again to recheck the squeegee blade deflection.
8. Readjust the squeegee blade deflection if necessary.
9. Raise the *Rear bumper door / step* when finished adjusting the rear squeegee blade deflection.

REPLACING OR ROTATING THE SIDE SQUEEGEE BLADES

1. If necessary, raise the scrub head.

FOR SAFETY: Before leaving or servicing machine, stop on level surface, turn off machine, set parking brake, and remove key.

2. Open the main brush access door and side squeegee support door.

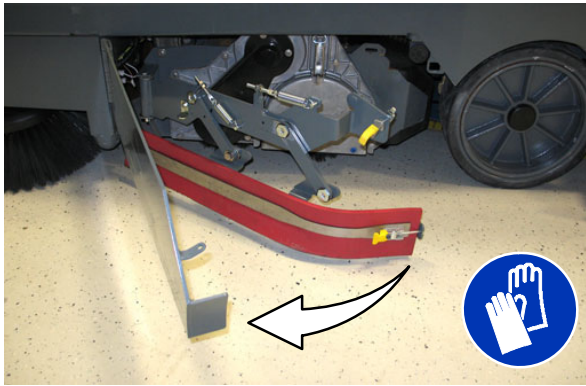

3. Unhook the retaining band latch from the side squeegee assembly.



4. Remove the retaining band from the side squeegee assembly.



5. Remove the squeegee blade from the side squeegee assembly.



6. Install the rotated or new rear squeegee blade onto the side squeegee assembly.

7. Hook the retaining band onto the retaining band retainer tab on the side squeegee assembly.

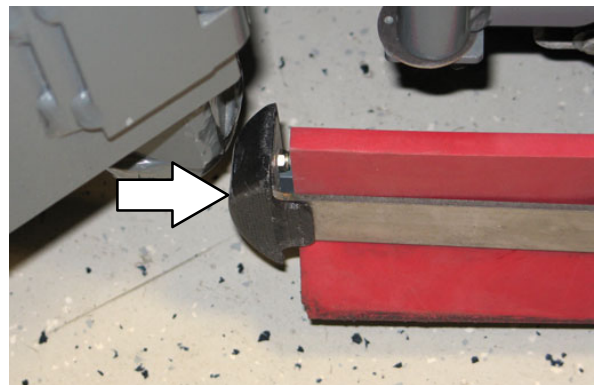

8. Fasten the retaining band latch onto the side squeegee assembly.



9. Close and secure the squeegee support door and close the main brush access door.

10. Repeat for the side squeegee on the other side of the scrub head.

MAINTENANCE

REPLACING OR ROTATING THE SIDE BRUSH SQUEEGEE BLADES (OPTION)

FOR SAFETY: Before leaving or servicing machine, stop on level surface, turn off machine, set parking brake, and remove key.

Check the side brush squeegee blades for damage and wear daily. Replace or rotate a blade if the leading edge is torn or worn half-way through the thickness of the blade.

1. Loosen the side brush squeegee assembly handle and remove the squeegee assembly from the machine.



2. Loosen the retaining band latch.



3. Remove the retaining band, squeegee blades, and spacer from the squeegee frame.

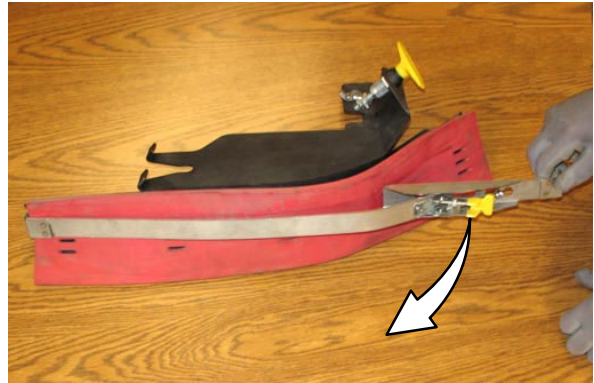

NOTE: Observe which squeegee slots were installed on the squeegee frame before removing the squeegee.



NOTE: The squeegee blade(s) have slots for adjusting the squeegee blade deflection. Install / reinstall squeegees so the deflection is approximately 12 mm (0.50 in) for smooth floors and 15 mm (0.62 in) for rough floors.

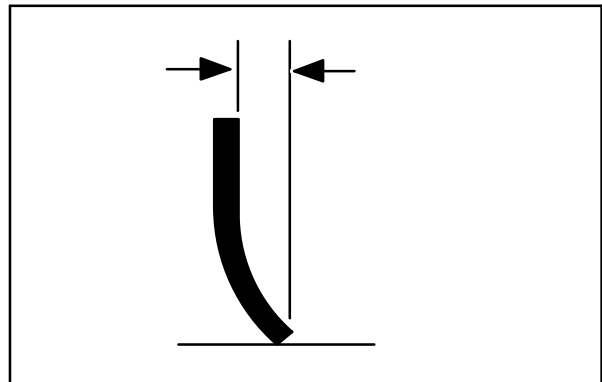

4. Install the rotated / new squeegee blades, spacer, and retaining band onto the side brush assembly. Be sure the holes in the squeegee blade are hooked onto the tabs.



5. Fasten the side brush retaining band latch.

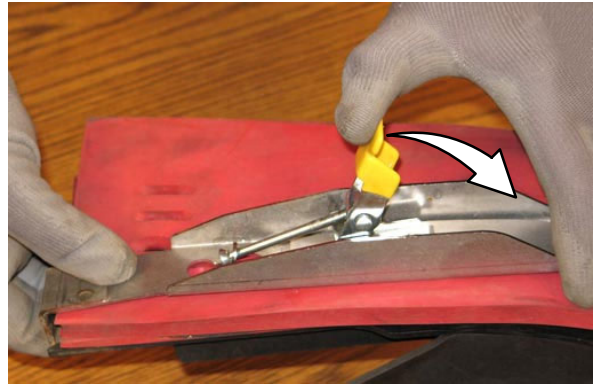

6. Reinstall the side brush squeegee assembly onto the side brush assembly.

MAINTENANCE

SKIRTS AND SEALS

FOR SAFETY: Before leaving or servicing machine, stop on level surface, turn off machine, set parking brake, and remove key.

RECOVERY TANK SEAL

Check the recovery tank cover seal for damage and wear daily.



SOLUTION TANK SEAL

Check the solution tank cover seal for damage and wear daily.



LIVE WAND VACUUM SEALS (OPTION)

Check the dry vacuum seals for damage and wear after every 50 hours of operation.

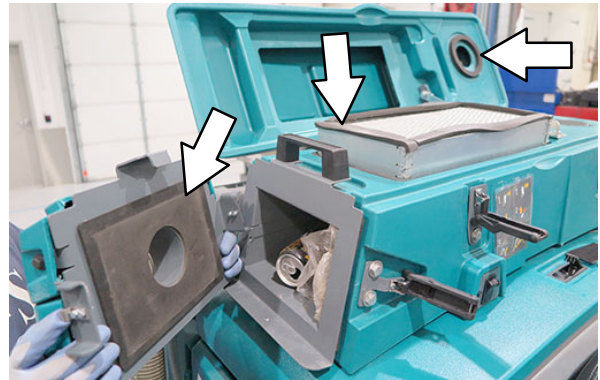

SCRUB HEAD SKIRTS (DISK SCRUB HEADS ONLY)

Check the scrub head skirts for damage and wear after every 50 hours of operation.



PRE-SWEEP SKIRTS (OPTION)

The Pre-Sweep skirts are located around the Pre-Sweep main brush.

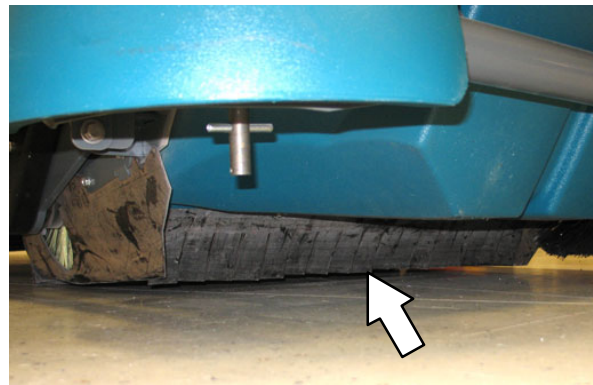
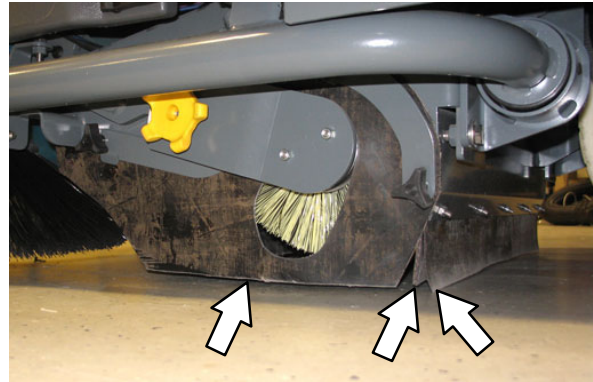

Check the skirts for damage and wear after every 50 hours of operation.

MAINTENANCE

BELTS

CYLINDRICAL BRUSH DRIVE BELTS

FOR SAFETY: Before leaving or servicing machine, stop on level surface, turn off machine, set parking brake, and remove key.

The brush drive belts are located on the cylindrical brush scrub head. Check the belts for damage and wear after every 200 hours of operation.

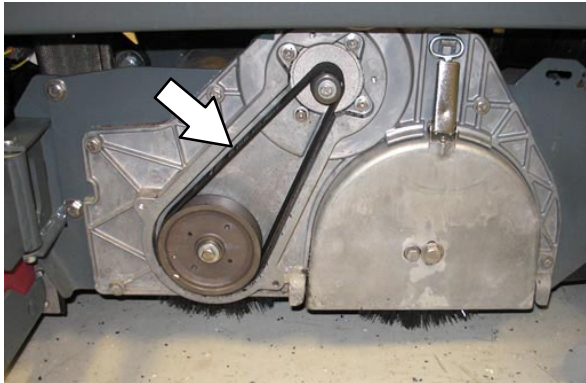

PRE-SWEEP BRUSH DRIVE BELT (OPTION)

FOR SAFETY: Before leaving or servicing machine, stop on level surface, turn off machine, set parking brake, and remove key.

The Pre-Sweep brush drive belt is located inside the Pre-Sweep assembly on the right side of the cylindrical brush. Check the belt for damage and wear after every 200 hours of operation.

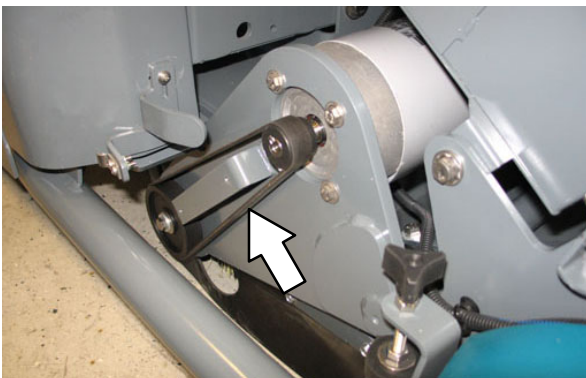

BRAKES

FOR SAFETY: Before leaving or servicing machine, stop on level surface, turn off machine, set parking brake, and remove key.

The foot brake and the parking brake operate the linkage that controls the brakes on the rear wheels.

The foot pedal should not travel more than 25 mm (1 in) to engage the brake. Check the brake adjustment after every 200 hours of operation.



TIRES

FOR SAFETY: Before leaving or servicing machine, stop on level surface, turn off machine, set parking brake, and remove key.

The machine has three solid rubber tires: one in front, and two in the rear of the machine. Check tires for damage and wear after every 500 hours of operation.

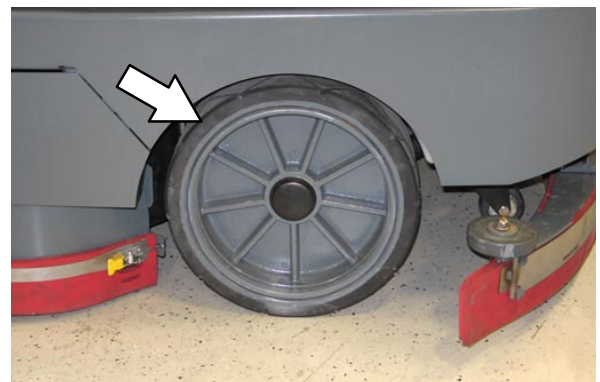

PUSHING, TOWING, AND TRANSPORTING THE MACHINE

PUSHING OR TOWING THE MACHINE

FOR SAFETY: When servicing the machine, do not push or tow the machine without an operator in the seat controlling the machine.

If the machine becomes disabled, it can be pushed from the front or rear, but it can only be towed from the front.

Only push or tow the machine for a *very short distance* and do not exceed 3.2 kp/h (2 mph). It is NOT intended to be pushed or towed for a long distance or at a high speed.

ATTENTION! Do not push or tow machine for a long distance or damage may occur to the propelling system.

TRANSPORTING THE MACHINE

1. Raise the squeegee, scrub head, and brushes.

FOR SAFETY: When loading/unloading machine onto/off truck or trailer, drain tanks before loading machine.

2. Park the trailer on a level surface and apply parking brake.
3. Position the machine at the loading edge of the truck or trailer.

FOR SAFETY: When loading/unloading machine onto/off truck of trailer, use ramp, truck or trailer that will support the weight of the machine and operator.

FOR SAFETY: When loading/unloading machine onto/off truck of trailer, do not load/unload on ramp inclines that exceed 21% / 12° grade

NOTE: The machine ability to climb a ramp is affected by tire wear, ramp surface, weather conditions, and other factors. Trailering should be performed by personnel trained on how to safely load a machine.

4. Drive the machine onto the trailer or truck. Position the machine so the weight of the machine is safely distributed and can be safely strapped down to the trailer or truck.

FOR SAFETY: When loading/unloading machine onto/off truck of trailer, stop on a level surface, set parking brake and leave the key in the ON position until all tie-down straps are secure.

NOTE: The drive wheel dynamic brake system is active when the key is in the ON position.

5. Lower the scrub head and rear squeegee.

MAINTENANCE

6. Place a block behind each wheel to prevent the machine from rolling.
7. Connect the tie-down straps to the right and left stabilizers in front of the machine.

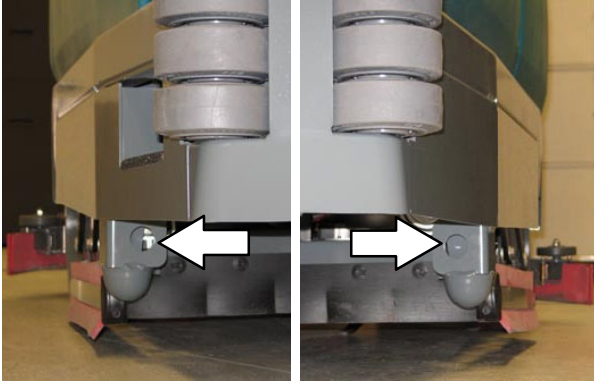

Machines with optional scrubbing side brush only: Connect one tie down strap to the step located on top the scrubbing side brush assembly and the other to the stabilizer located on the other side of the machine.

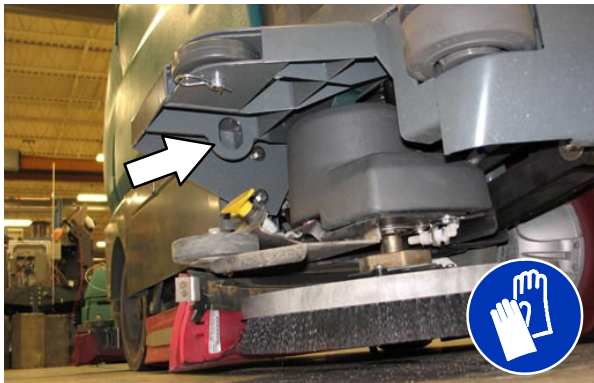

8. Connect the tie-down straps to the holes in the rear jacking brackets at the rear of the machine.

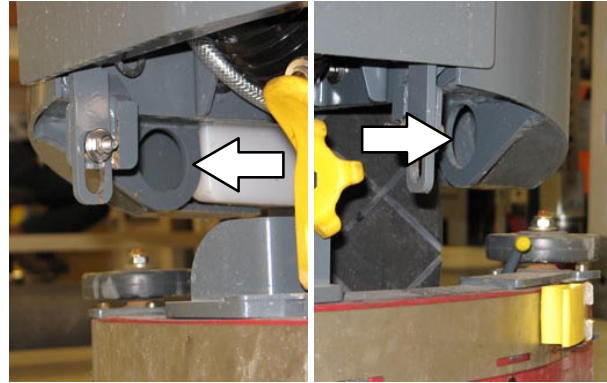

9. Turn off machine and remove the key after the machine is secured.

MACHINE JACKING

FOR SAFETY: Before leaving or servicing machine, stop on level surface, turn off machine, set parking brake, and remove key.

Empty the recovery and solution tanks before jacking the machine.

Jacking point location at the front of all machines.

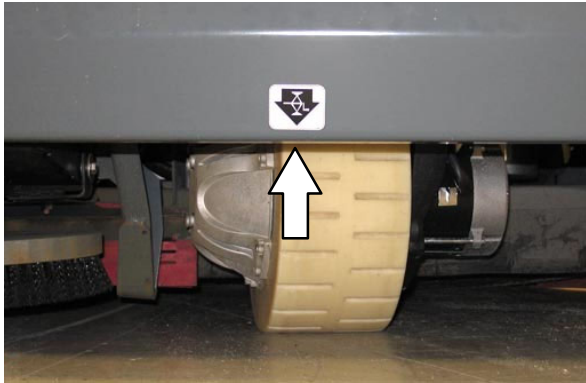

Jacking point locations at the front of machines equipped with the Pre-Sweep option.

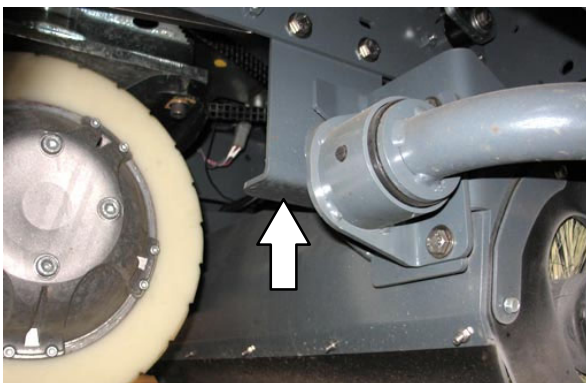
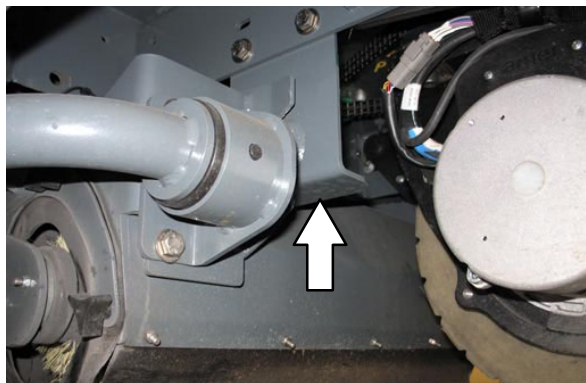

Jacking point location at the rear of all machines.



FOR SAFETY: When servicing machine, block machine tires before jacking machine up. Use a hoist or jack that will support the weight of the machine. Jack machine up at designated locations only. Support machine with jack stands.

***ec-H2O* MODULE FLUSH PROCEDURE**

This procedure is only required when the red indicator light begins to flash and there is an audible alarm.

FOR SAFETY: Before leaving or servicing machine, stop on level surface, turn off machine, and set parking brake.

1. Open the right shroud to access the *ec-H2O* assembly.
2. Press the connector button to disconnect the outlet hose from the *ec-H2O* manifold.

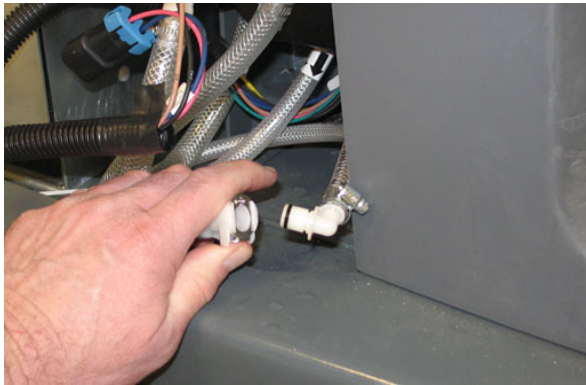

NOTE: Look for arrows on the hose near where the hose is coming from the bottom of the *ec-H2O* assembly to determine which hose is the outlet hose.

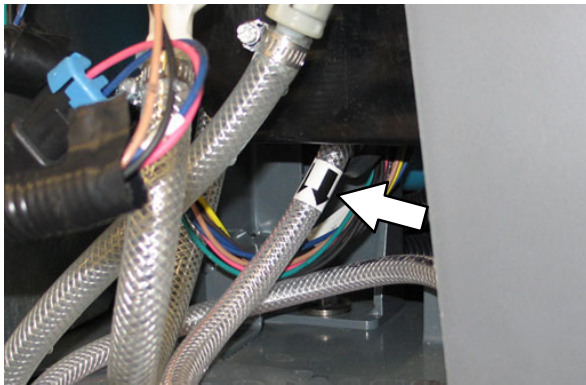

3. Remove the drain hose from the *ec-H2O* compartment.

4. Connect the drain hose to the *ec-H2O* outlet hose.



5. Place the drain hose into a empty container.



6. Pour 2 gallons (7.6 liters) of white or rice vinegar into the solution tank.

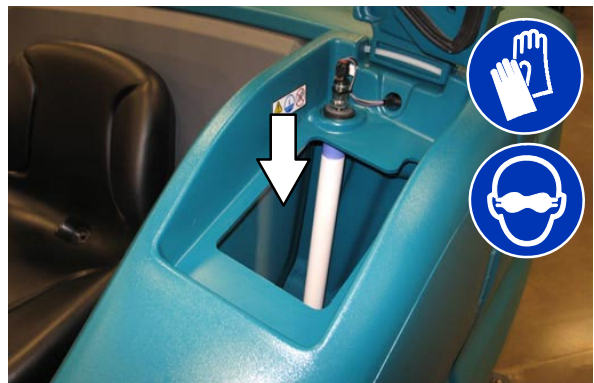

7. Start the machine.
8. Press and release the *ec-H2O* module flush switch to start the flush cycle.

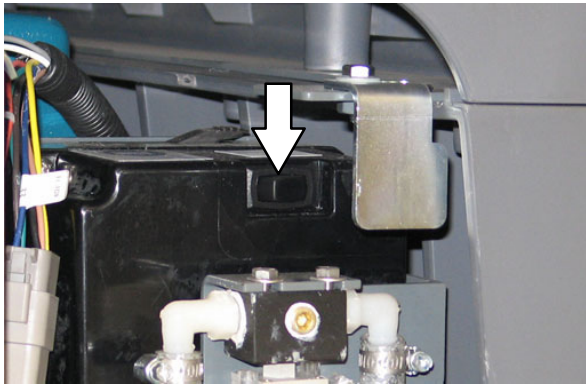

NOTE: The module will automatically shut off when the flush cycle is complete (approximately 7 minutes). The module must run the full 7-minute cycle in order to reset the system indicator light and alarm.

9. Pour 2 gallons (7.6 liters) of cool clean water into the solution tank.
10. Press and release the flush switch to rinse any remaining vinegar from the module. After 1–2 minutes, press the flush switch to turn off the module.
11. Disconnect the drain hose from the *ec-H2O* manifold hose.
12. Reconnect the outlet hose to the *ec-H2O* manifold hose.
13. Return the drain hose to storage location in the *ec-H2O* compartment.
14. Close the right shroud.

STORAGE INFORMATION

The following steps should be taken when storing the machine for extended periods of time.

1. Charge the batteries before storing machine to prolong the life of the batteries. Recharge batteries once a month.
2. Disconnect batteries before storing.
3. Thoroughly drain and rinse the solution and recovery tanks.
4. Store the machine in a dry area with the squeegee and scrub head in the up position.

ATTENTION: Do not expose machine to rain, store indoors.

5. Open the recovery tank cover to promote air circulation.
6. If storing machine in freezing temperatures, proceed to *FREEZE PROTECTION*.

NOTE: To prevent potential machine damage store machine in a rodent and insect free environment.

FREEZE PROTECTION

FOR SAFETY: Before leaving or servicing machine, stop on level surface, turn off machine, and set parking brake.

1. Completely drain the solution tank, recovery tank, and detergent tank.
2. Pour 7.6 L (2 gal) of Propylene Glycol Based / Recreational Vehicle (RV) antifreeze into the solution tank.



3. Machines equipped with optional detergent tank only: Pour 1.9 L (1/2 gal) of Propylene Glycol Based / Recreational Vehicle (RV) antifreeze into the detergent tank.



4. Turn on the machine.
5. Press the *1-Step button*.



- Repeatedly press the *Solution increase button (+)* until the solution flow is at the highest setting.

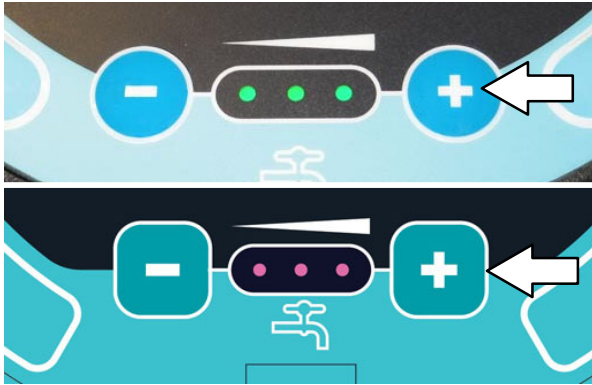

Standard Panel



Pro-Panel

- Machines with severe environment switch option only:** Press the bottom of the *severe environment switch* or the severe environment button to activate the severe environment scrubbing system.



Standard Panel

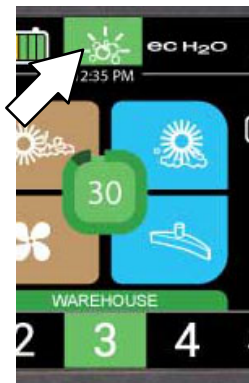

Pro-Panel

- Machines with scrubbing side brush option only:** Press the *side brush switch* or side brush button to activate the side brush.

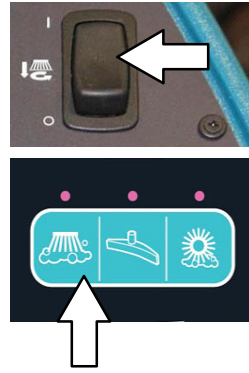

Standard Panel



Pro-Panel

- Drive the machine to circulate the antifreeze completely through all the systems and clear out any remaining water.
- Machines with scrubbing side brush option only:** Press the *side brush switch* to turn off the side brush.
- Stop the machine.
- Machines with spray nozzle option only:** Operate the wand for a few seconds to protect the pump.
- Machines with high pressure washer option only:** Prime the high pressure washer with the antifreeze and operate the high pressure washer for a few seconds to protect the pump. See *PRIMING THE HIGH PRESSURE WASHER PUMP*.
- Press the *1-STEP button* to turn off the system.
- Turn off the machine.
- The remaining antifreeze does not need to be drained from the solution tank, recovery tank, or detergent tank.

MAINTENANCE

PREPARING THE MACHINE FOR OPERATION AFTER STORAGE

All antifreeze must be completely cleaned from the scrubbing system before the machine can be used for scrubbing.

FOR SAFETY: Before leaving or servicing machine, stop on level surface, turn off machine, and set parking brake.

1. Completely drain all antifreeze from the solution tank.
2. Rinse out the solution tank. Refer to *DRAINING AND CLEANING THE SOLUTION TANK* in the *OPERATION* section for instructions how to clean the solution tank.
3. Pour 11.4 L (3 gal) of cool clean water into the solution tank.



4. Machines equipped with optional detergent tank only: Pour 1.9 L (1/2 gal) of cool clean water into the detergent tank.



5. Start the machine

6. Press the 1-STEP button.



7. Repeatedly press the Solution increase button (+) until the solution flow is at the highest setting.

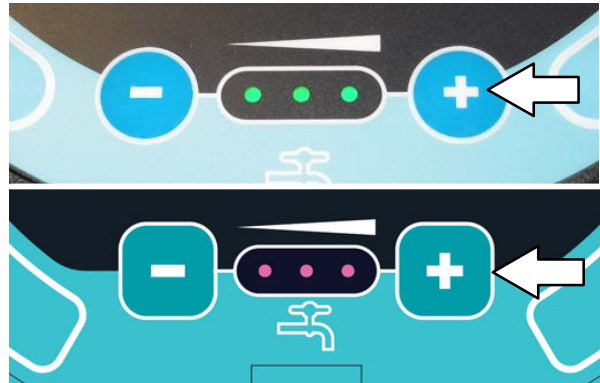

Standard Panel



Pro-Panel

NOTE: The ec-H2O systems on machines equipped with ec-H2O must be primed before the machine is ready for operation. See *PRIMING THE ec-H2O SYSTEM* for additional instructions.

8. **Machines with severe environment switch option only:** Press the bottom of the *severe environment switch* to activate the severe environment scrubbing system.

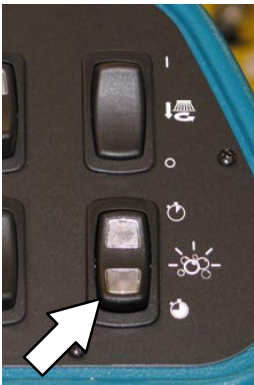

Standard Panel



Pro-Panel

9. **Machines with scrubbing side brush option only:** Press the *side brush switch* to activate the side brush.

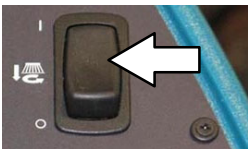

Standard Panel

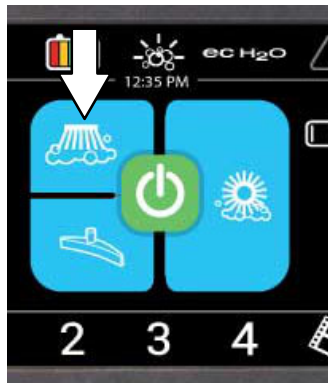

Pro-Panel

10. Drive the machine until all water and antifreeze is emptied from the tanks.
11. **Machines with scrubbing side brush option only:** Press the *side brush switch* to turn off the side brush.

NOTE: Machines equipped with optional ES system will need to drain the antifreeze from the pump lines.

12. Stop the machine.
13. **Machines with spray nozzle option only:** Operate the wand for a few seconds to clean the antifreeze from the pump.
14. Press the *1-STEP button* to turn off the system.

15. **Machines with high pressure washer option only:** Unhook the return line to the solution tank and place into a bucket.



Operate the pressure washer for a few seconds to drain antifreeze from the pump. Release the trigger for a few more seconds which will drain the antifreeze from the return line into the bucket. Turn off the pressure washer switch and reconnect the return line to the solution tank.

WARNING: Do not spray people or animals. Severe personal injury can result. Wear eye protection. Hold sprayer with two hands.

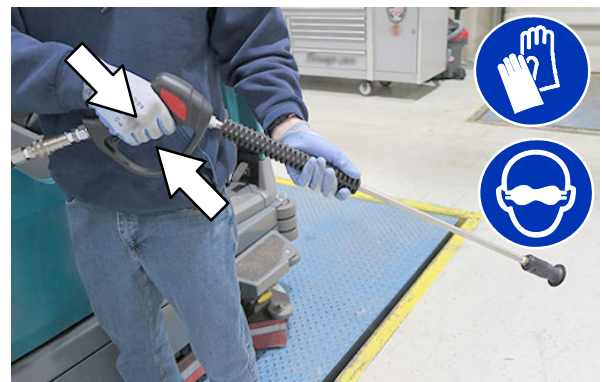

16. Turn off the machine.

MAINTENANCE

PRIMING THE *ec-H2O* SYSTEM

Prime the *ec-H2O* system if the machine has been stored for a long period with no water in the solution tank / *ec-H2O* system.

FOR SAFETY: Before leaving or servicing machine, stop on level surface, turn off machine, and set parking brake.

1. Fill the solution tank with clean cool water. See *FILLING THE SOLUTION TANK* section of this manual.



2. Open the right shroud to access the *ec-H2O* assembly.
3. Press the connector button to disconnect the outlet hose from the *ec-H2O* manifold.

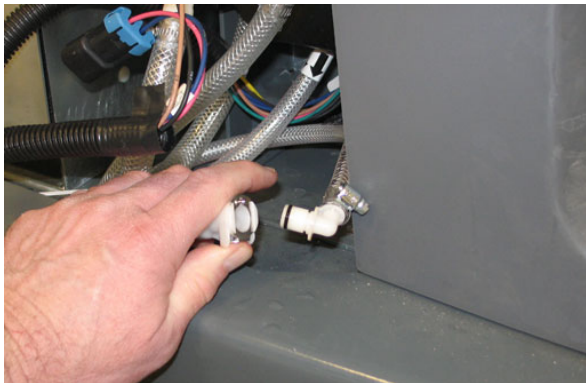

NOTE: Look for arrows on the hose near where the hose is coming from the bottom of the *ec-H2O* assembly to determine which hose is the outlet hose.

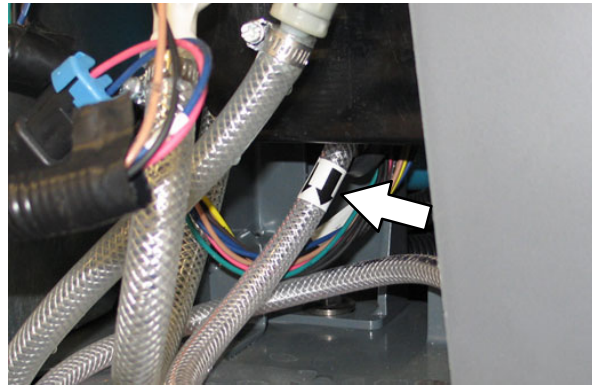

4. Remove the drain hose from the *ec-H2O* compartment.
5. Connect the drain hose to the *ec-H2O* outlet hose.



6. Place the drain hose into a empty container.



7. Start the machine.
8. Press and release the *ec-H2O* module flush switch. Allow the system to drain water into the container for 2 minutes.

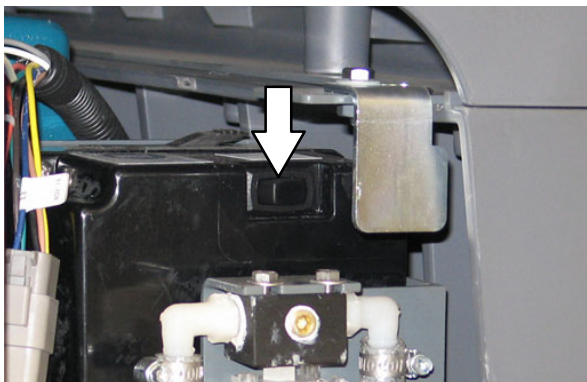

9. Press the *ec-H2O* module flush switch to shut off the system.
10. Disconnect the drain hose from the *ec-H2O* manifold hose.
11. Reconnect the outlet hose to the *ec-H2O* manifold hose.
12. Place the drain hose back into the *ec-H2O* compartment.
13. Close the right shroud.

SPECIFICATIONS

SPECIFICATIONS

GENERAL MACHINE DIMENSIONS/CAPACITIES

Item	Dimension/capacity
Length (S/N 1200-)	2245 mm (88.4 in)
Length (S/N 0000-1199)	2230 mm (87.9 in)
Length (with Pre-Sweep) (S/N 1200-)	2880 mm (113.4 in)
Length (with Pre-Sweep) (S/N 0000-1199)	2870 mm (113 in)
Width (less squeegee)	1168 mm (46 in)
Width (with squeegee)	1245 mm (49 in)
Width (with side brush)	1346 mm (53 in)
Wheel base	1163 mm (45.8 in)
Height (top of steering wheel)	1480 mm (58.25 in)
Height (with high pressure washer option)	1680 mm (66.2 in)
Height (with live wand option – Pro-Panel)	1766 mm (69.5 in)
Height (with live wand option w/ rear view mirror)	1979 mm (77.9 in)
Height (with overhead guard)	2096 mm (82.5 in)
Track	1041 mm (41 in)
Disk brush diameter	510 mm (20 in)
Cylindrical brush diameter	230 mm (9 in)
Cylindrical brush length	1015 mm (40 in)
Disk brush diameter for scrubbing side brush (option)	411 mm (16.18 in)
Disk brush diameter for sweeping side brush (option)	482.60 mm (19 in)
Disk brush diameter for Pre-Sweep (option)	482.60 mm (19 in)
Cylindrical sweep brush diameter for Pre-Sweep (option)	203.20 mm (8 in)
Cylindrical sweep brush length for Pre-Sweep (option)	709.68 mm (27.94 in)
Scrubbing path width	1015 mm (40 in)
Scrubbing path width (with scrubbing side brush)	1320 mm (52 in)
Scrubbing path width (with right sweeping side brush)	1165 mm (46 in)
Scrubbing path width (with dual sweeping side brushes)	1320 mm (52 in)
Solution tank capacity	285 L (75 gallons)
Recovery tank capacity	346 L (91.1 gallons)
Detergent tank capacity (option)	17.6 L (4.6 gallons)
Demisting chamber	61 L (16.1 gallons)
Weight (Empty)	875 Kg (1925 lbs)
Weight (with standard 510 AH batteries)	1525 Kg (3365 lbs)
GVWR	2790 Kg (6150 lbs)
Protection Grade	IPX3

SPECIFICATIONS

Values determined as per IEC 60335-2-72	Measure – Cylindrical scrub head	Measure – Disk scrub head
Sound pressure level L_{pA}	68 dB(A)	65 dB(A)
Sound pressure uncertainty K_{pA}	2.8 dB(A)	3.0 dB(A)
Sound power level L_{WA} + Uncertainty K_{WA}	88.2 dB(A)	85.8 dB(A)
Vibration – Hand–arm	<2.5 m/s ²	<2.5 m/s ²
Vibration – Whole body	<0.5 m/s ²	<0.5 m/s ²

GENERAL MACHINE PERFORMANCE

Item	Measure
Aisle turnaround width	2370 mm (93.25 in)
Aisle turnaround width (with Pre–Sweep)	2941 mm (115.75 in)
Travel Speed (Forward)	9 Km/h (5.5 mph)
Travel Speed while scrubbing (Forward)	6.5 Km/h (4 mph)
Travel Speed (Reverse)	5 Km/h (3 mph)
Maximum ramp incline for loading – Empty	21%
Maximum ramp incline for scrubbing	8.7%
Maximum ramp incline for scrubbing (With optional ramp kit)	10.5%
Maximum ramp incline for transporting (GVWR)	12%
Maximum ramp incline for transporting (GVWR) (With optional ramp kit)	14.8%
Maximum ambient temperature for machine operation	43° C (110° F)
Minimum temperature for operating machine scrubbing functions	0° C (32° F)

POWER TYPE

Type	Quantity	Volts	Ah Rating	Weight
Batteries (Max. battery dimensions: 406 mm (15.98 in) W x 963 mm (37.91 in) L x 775 mm (30.51 in) H	1	36	625 @ 5 hr rate	689 kg (1519 lb)
	1	36	775 @ 5 hr rate	836 kg (1843 lb)

Type	Use	VDC	kW (hp)
Electric Motors	Scrub brush (disk)	36	1.125 (1.50)
	Scrub brush (cylindrical)	36	1.125 (1.50)
	Vacuum fan	36	0.6 (0.8)
	Propelling	36	2.25 (3.0)
	High pressure washer	36	2.25 (3.0)
	Live wand vacuum	36	1.125 (1.5)

Type	VDC	amp	Hz	Phase	VAC
Chargers (Smart)	36	21	45–65	1	85–265

SPECIFICATIONS

TIRES

Location	Type	Size
Front (1)	Solid	150 mm wide x 350 mm OD (5.8 in wide x 13.8 in OD)
Rear (2)	Solid	125 mm wide x 380 mm OD (5 in wide x 15 in OD)

SCRUBBING SIDE BRUSH SOLUTION FLOW RATE (OPTION)

Item	Measure
Solution pump	36 Volt DC up to 1.51 LPM (0.40 GPM)

ec-H₂O SYSTEM (OPTION)

Item	Measure
Solution pump	36 Volt DC, 5A, 6.8 LPM (1.8 GPM) open flow
Solution flow rate (machines without optional scrubbing side brush)	Up to 3.79 LPM (1.0 GPM)
Solution flow rate (machines with optional scrubbing side brush)	Up to 2.65 LPM (0.70 GMP) – To main scrub head
	Up to 1.14 LPM (0.30 GPM) – To scrubbing side brush

HIGH PRESSURE WASHER (OPTION)

Item	Measure
Pump pressure (max)	Up to 17236 kpa (2500 psi)
Solution flow rate (max @ 2500psi)	Up to 7.57 LPM (2.0 GPM)

MACHINE DIMENSIONS

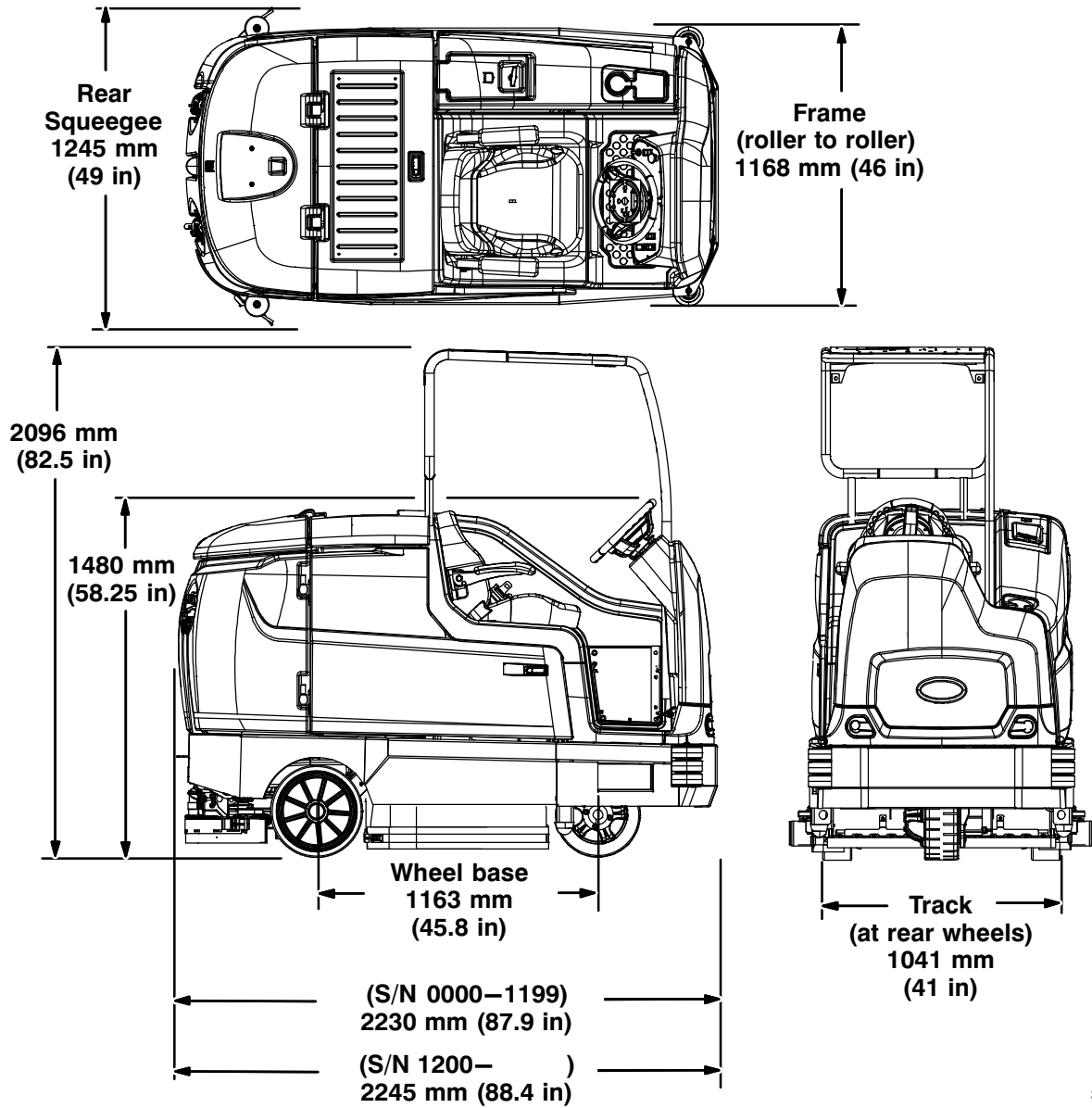

356389

SUPERVISOR CONTROLS

PRO-PANEL SUPERVISOR CONTROLS

The supervisor controls feature allows a supervisor to program the machine scrubbing settings for operator use. The lockout functionality will prevent the operator from changing or saving the settings.

The supervisor controls feature will lower machine variability for consistent, repeatable cleaning results, machine quality assurance regardless of user experience, and reduce user training requirements.

There are two types of user modes that will interface with the operator home screen:

Operator Mode – Capable of machine operation with permissions and restrictions controlled by the supervisor.

Supervisor Mode – Capable of machine operation with full use of all controls, along with configuring permissions and restrictions for the operator mode.

A new machine from the factory will automatically start in the supervisor mode with a preassigned default supervisor profile. The factory-assigned supervisor login number is “1234”. This login number is not required until it is enabled. The default supervisor profile name and login number can be changed as described in this section. If the new assigned supervisor mode login number is forgotten, please contact Tennant service.

ENTERING THE SUPERVISOR MODE – FIRST TIME USE ONLY

1. Turn on the machine. The main operating screen will appear in the display.
2. Press the help button to access the help screen.

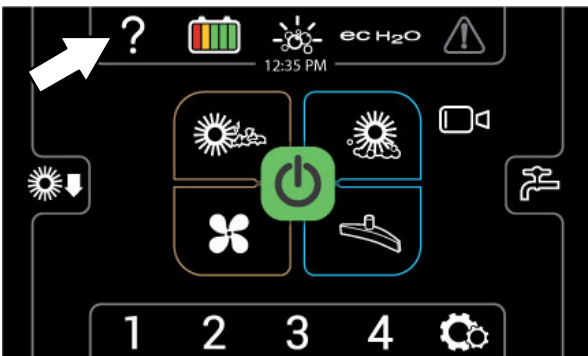

3. Press the logout button.

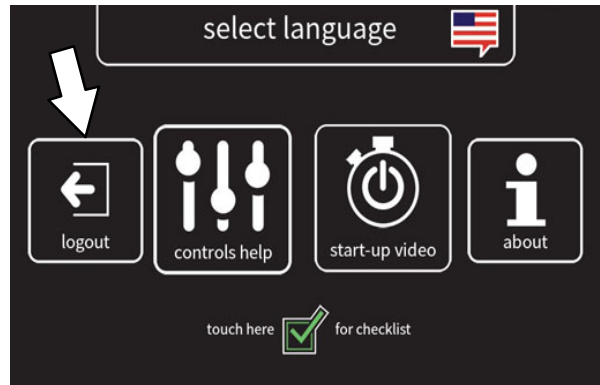

4. Use the keypad to enter the factory assigned supervisor login number 1234 into the display above the keypad. Press the enter button when finished entering the supervisor login number.

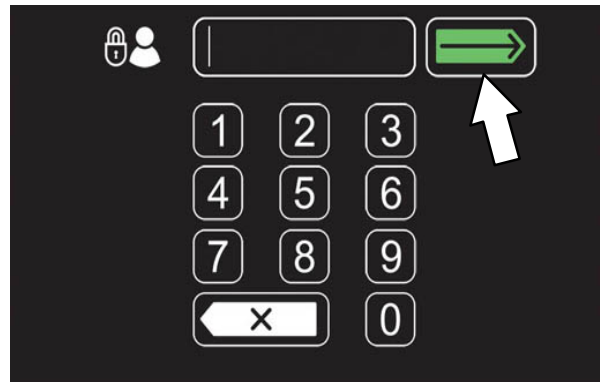

 Press the backspace button if necessary to delete and reenter a number.

5. The supervisor machine operation screen should appear in the display. Press the settings button to access the supervisor settings screen.

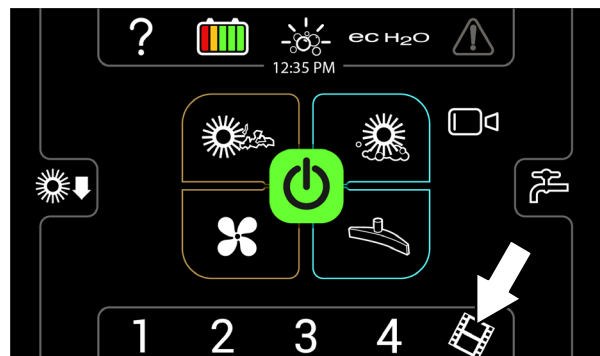

6. Proceed to *ADDING / EDITING PROFILES*.

ENTERING THE SUPERVISOR MODE

1. Turn on the machine. The login screen will appear on the display.
2. Use the keypad to enter the supervisor login number into the display above the keypad. Press the enter button when finished entering the supervisor login number.

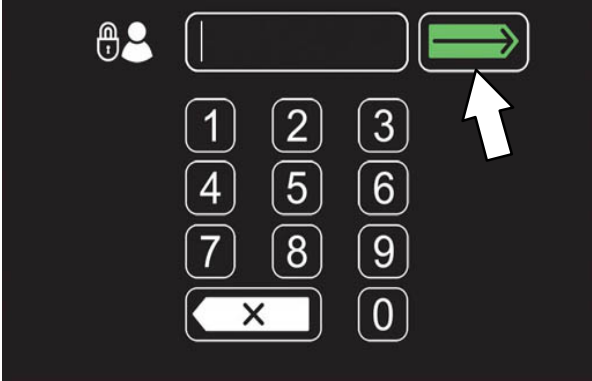

 Press the backspace button if necessary to delete and reenter a number.

3. The supervisor machine operation screen should appear in the display. Press the settings button to access the supervisor settings screen.

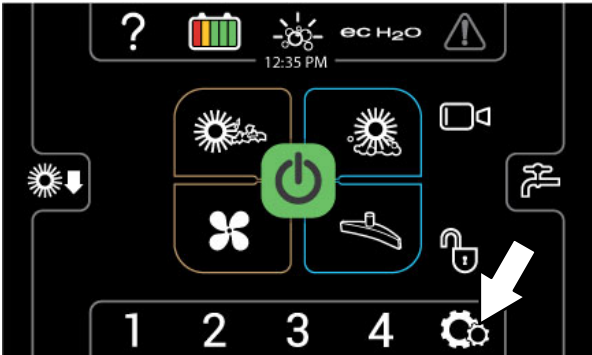

SUPERVISOR CONTROLS

SUPERVISOR SETTING SCREEN / SCREEN ICONS

Use the supervisor maintenance screen to setup / change user passwords, user machine settings, and other machine setup items.

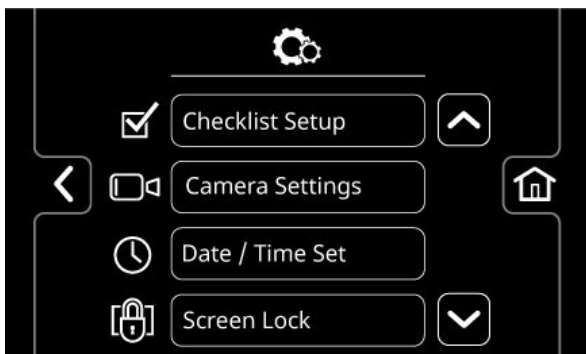
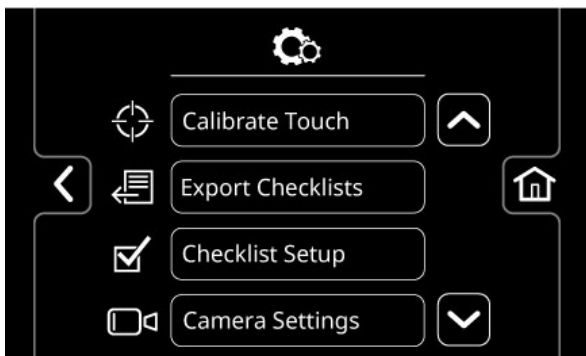
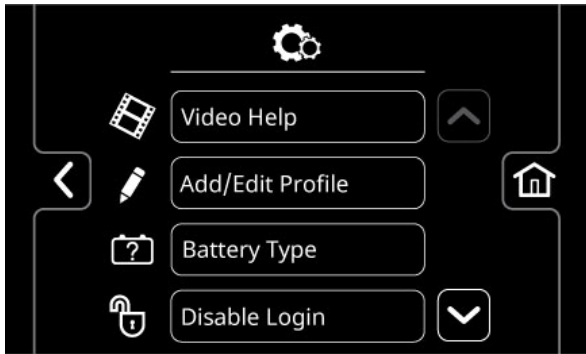

Use the below menu buttons to access the various supervisor setup menus / screens.



Press the video help button to access the various machine help videos.



Press the Add / Edit Profiles button to add, delete, and / or change machine user and supervisor profiles. See *ADDING / EDITING PROFILES*.



Press the Battery Type button to change the type of battery being used in the machine. See *CHANGING BATTERY TYPE*.



Press the Enable Login button to activate a required login number at machine start up for all user profiles to operate machine.



Press the Disable Login button to deactivate a login number at machine start up for all user profiles to operate machine. See *DISABLING LOGIN*



Press the Calibrate Touch button to calibrate the touch screen if the touch points become misaligned.



Press the Export Checklists button to access the Export Checklists menu. See *EXPORTING CHECKLISTS*.



Press the Checklists Setup button to access the Checklist Setup menu. See *DISABLING / ENABLING THE PREOPERATION CHECKLIST*.



Press the Camera Settings button to access the Camera Settings screen. See *CHANGING REARVIEW CAMERA SETTINGS*.



Press the Date / Time Set button to set the machine date and time. See *SETTING / CHANGING THE DATE AND TIME*.



Press the Screen Lock button to access the Screen Lock setting Screen. See *SETTING THE SCREEN LOCK*.



Press the up arrow button to navigate up through the menu items.



Press the down arrow button to navigate down through the menu items.



Press the home button to navigate back to the main operating screen.



Press the back button to navigate back to the previous screen.





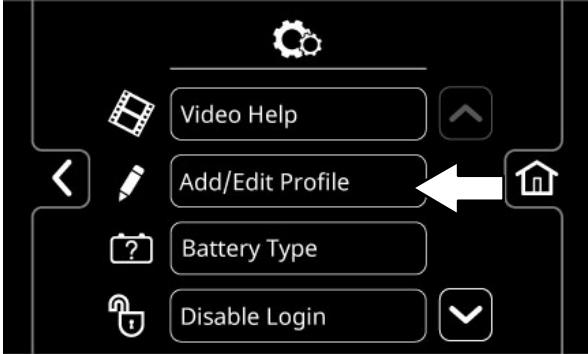

ADDING / EDITING PROFILES

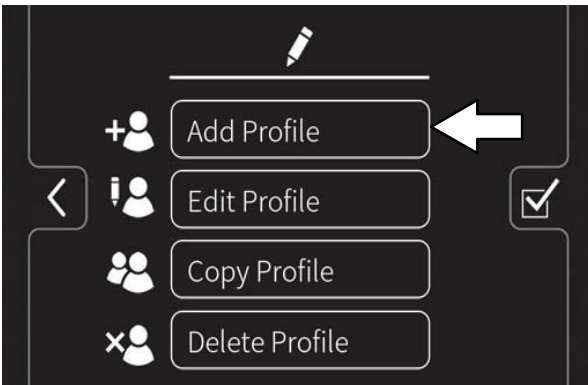
1. Turn on the machine, log into the supervisor screen, and press the settings button to access the supervisor settings screen. See *ENTERING THE SUPERVISOR MODE*.
2. Press the Add/Edit Profiles button to access the Add/Edit Profiles screen.



3. Press the Add Profile button to access the Add Profile screen.



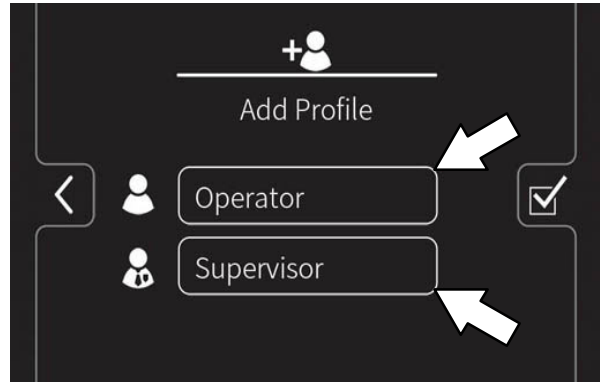

-  Press the Add Profile button to access the screens and menus to add a new profile.
-  Press the Edit Profile button to edit an existing profile.
-  Press the Copy Profile button to copy an existing profile.
-  Press the Delete Profile button to delete an existing profile.
-  Press the home button to navigate back to the main operating screen.
-  Press the back button to navigate back to the previous screen.

4. Press the Operator button to add a new operator, or Supervisor button to add a new supervisor.



NOTE: The default supervisor cannot be deleted from the profile list.

-  Press the Operator button to add / edit / copy / delete an operator profile.
-  Press the Supervisor button to add / edit / copy / delete a supervisor profile.

5. Use the keypad to enter the new user / supervisor name. Press the enter button.



SUPERVISOR CONTROLS

- Use the keypad to assign the new user / supervisor a login number. The new login number can be any combination of numbers ranging from 3 to 8 digits in length. Press the enter button.



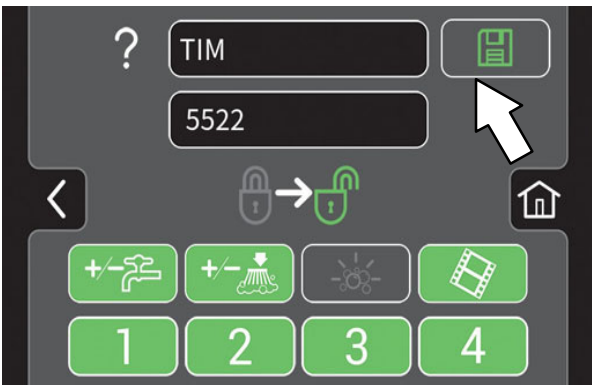

 Press the backspace button if necessary to delete and reenter a number.

- Select the controls the new user should have access to use. Green represents unlocked controls and gray represents locked controls. Press the flashing save button to save the new profile.

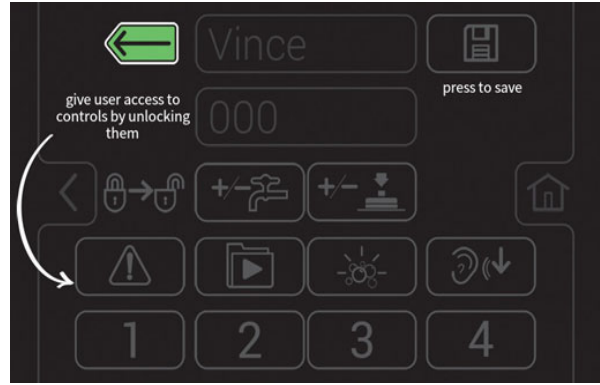

 Press the help button to access the help screen.



 Press the back button to return to the user access page.

- The new user profile is now saved to the operator profile list. Multiple operator and supervisor user profiles can be added. Press the back arrow button to return to the previous screen to add more user profiles or to enable login.
- To enable the login number at start up, press the Enable Login button.

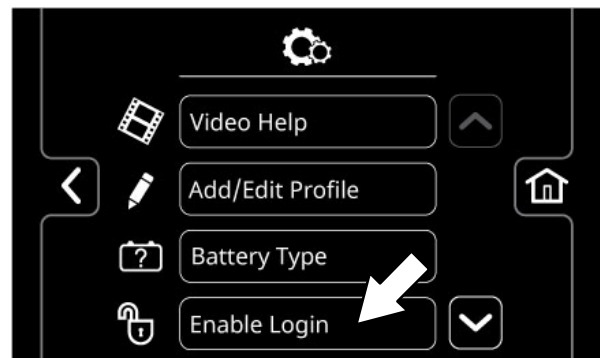

The Enable Login button will change from Enable Login to Disable Login. See *DISABLING LOGIN* for instructions how to disable login.

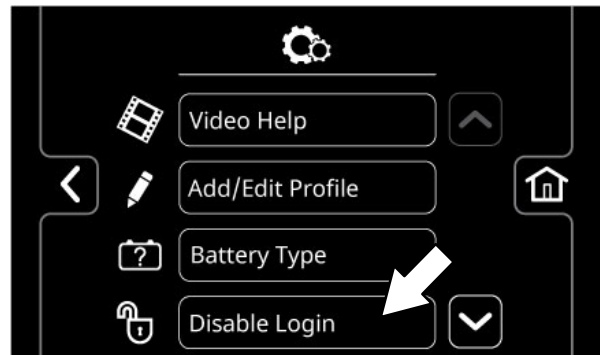

10. Now at machine start up, a login screen will display. The new user will need to enter their assigned login number to operate machine.
11. When the user is done operating the machine, it is recommended the user log out by pressing the help button, and then pressing the logout button. Turning the key to the off position is another way to also logout.
12. Use the Edit Profile button, Copy Profile button, and Delete Profile button to manage the current user profiles.

ENABLING THE LOGIN

1. Turn on the machine, log into the supervisor screen, and press the settings button to access the supervisor settings screen. See *ENTERING THE SUPERVISOR MODE*
2. Press the Enable Login button.

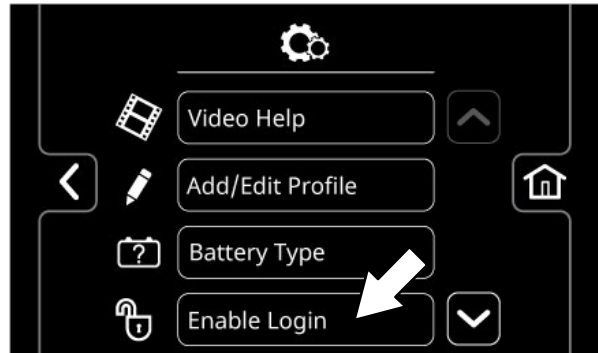

3. Press the yes button to enter the Default User screen.

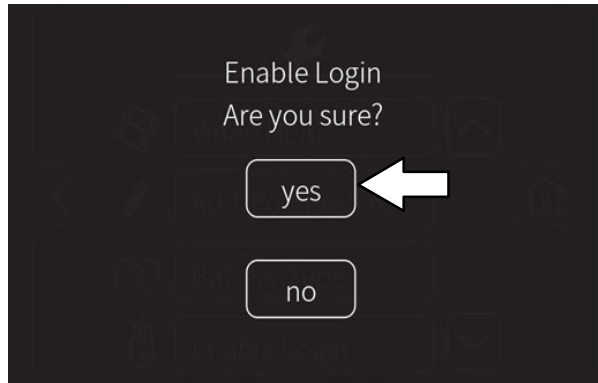

4. Press either the Operator button or Supervisor button to select the desired default user.

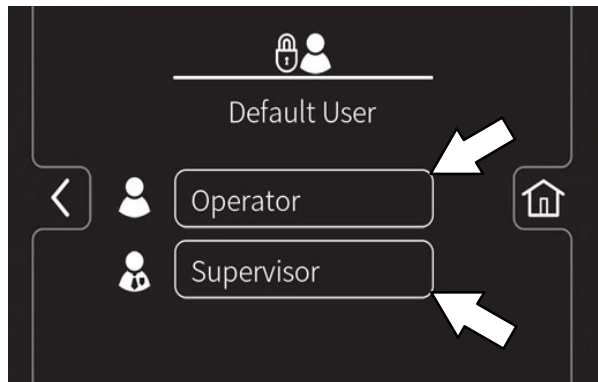

SUPERVISOR CONTROLS

DISABLING THE LOGIN

1. Turn on the machine, log into the supervisor screen, and press the settings button to access the supervisor settings screen. See *ENTERING THE SUPERVISOR MODE*
2. Press the Disable Login button.



3. Press the yes button to enter the Default User screen.

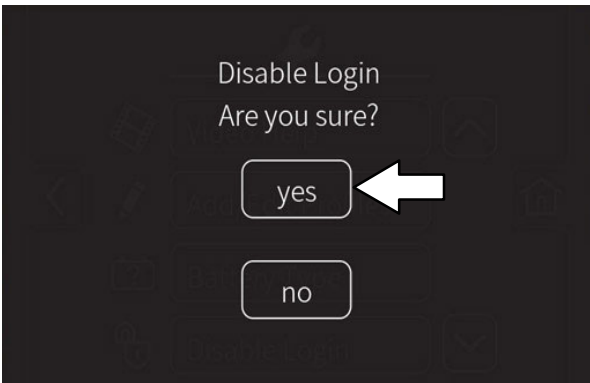

4. Press either the Operator button or Supervisor button to select the desired default user.

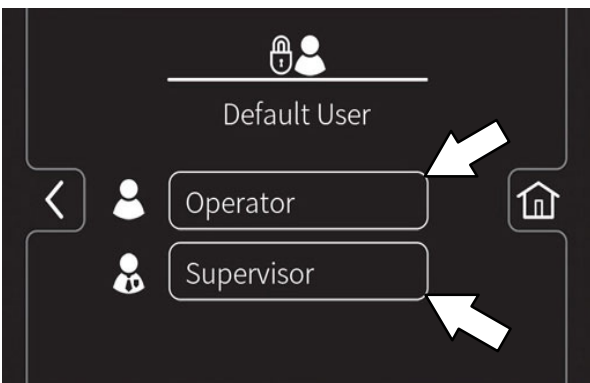

5. Select a pre-assigned user profile. Turn off the machine to apply the setting.

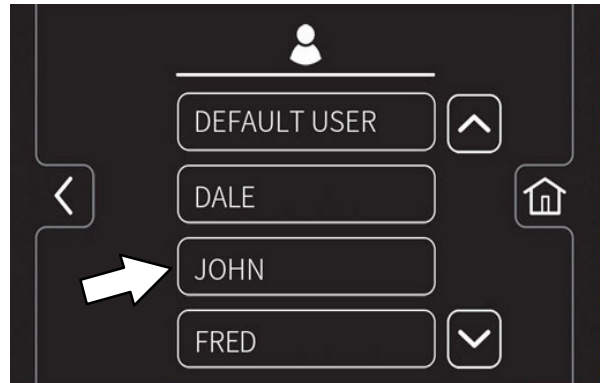

6. At start up, the home screen is now set without a login requirement for the operator profile as the default.

CHANGING THE BATTERY TYPE

Changing the battery type allows the machine to be programmed for the correct battery type if the battery has been changed.

IMPORTANT: Before charging, make sure that the charger setting is properly set for the battery type.

NOTE: Use a charger with the proper rating for the battery to prevent damage to the battery or reduce the battery life.

1. Turn on the machine, login to the main operation screen, and press the setting button to access the supervisor settings screen. See *ENTERING THE SUPERVISOR MODE*.
2. Press the Battery Type button to access the battery selection screen.



3. Press the button for the applicable battery from the list. If necessary, use the up arrow button and the down arrow button to navigate through the list of batteries.

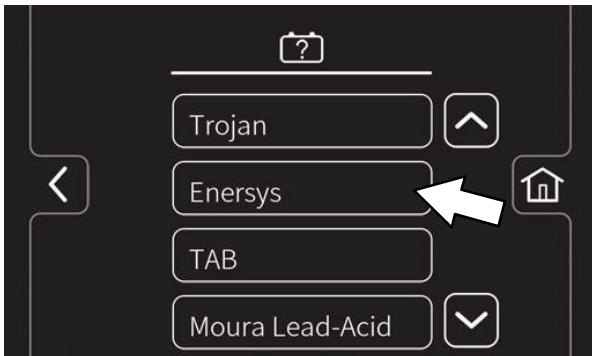

4. If a battery sub list appears on the screen, press the button for the applicable battery from the list.

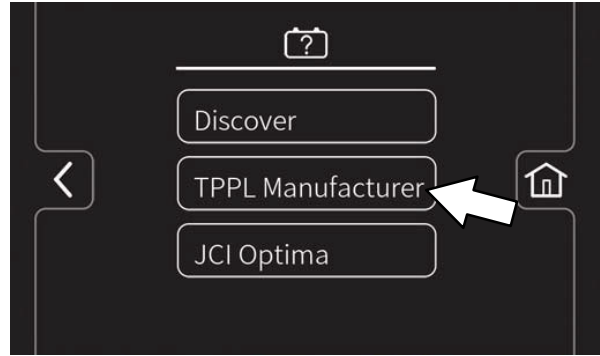

5. If Are You Sure appears on the screen, press either the yes button or the no button.



NOTE: If yes button is pushed the supervisor settings screen will reappear in the display. If the no button is pushed the applicable battery sub list will reappear in the display.

CALIBRATING THE TOUCH

1. Turn on the machine, login to the main operation screen, and press the setting button to access the supervisor settings screen. See *ENTERING THE SUPERVISOR MODE*
2. Press the Calibrate Touch button to recalibrate touch if the touch points become misaligned.

SUPERVISOR CONTROLS

EXPORTING CHECKLISTS

Exporting the checklists allows the checklists to be exported from the machine and to a flash drive.

1. Turn on the machine, log into the supervisor screen, and press the settings button to access the supervisor settings screen. See *ENTERING THE SUPERVISOR MODE*
2. Plug the flash drive into the USB port.



3. Press the Export Checklists button to access the export screen.

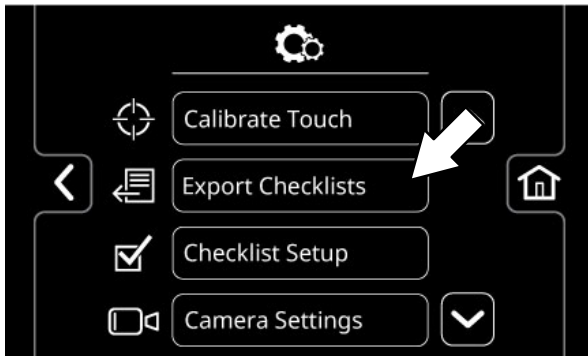

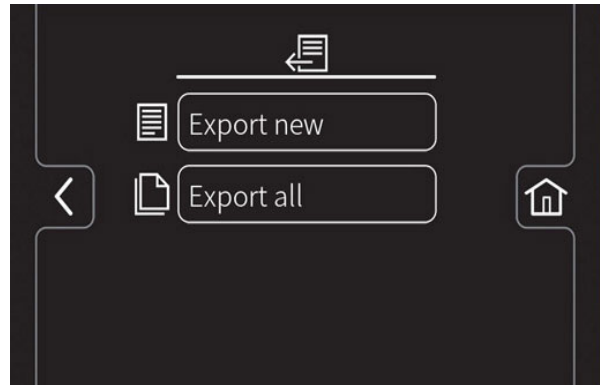

4. Export the Pre-Operation Checklists from the machine to the memory stick.



 Press the Export New button to export the newly completed Pre-Operation Checklists from the machine.

NOTE: All checklists that have not been previously exported are flagged.

 Press the Export All button to export all completed Pre-Operation Checklists from the machine.

 Press the home button to navigate back to the main operating screen.

 Press the back button to navigate back to the previous screen.

5. Remove the flash drive from USB port and turn off the machine.

CHECKLIST SETUP

Checklist setup allows the checklist to be setup / changed to meet machine usage demands.

1. Turn on the machine, login to the main operation screen, and press the setting button to access the supervisor settings screen. See *ENTERING THE SUPERVISOR MODE*.
2. Press the Checklist Setup button to access the Pre-Operation checklist setup screen.



3. Press the Select Questions button to access the Pre-Operation Checklist master list screen.

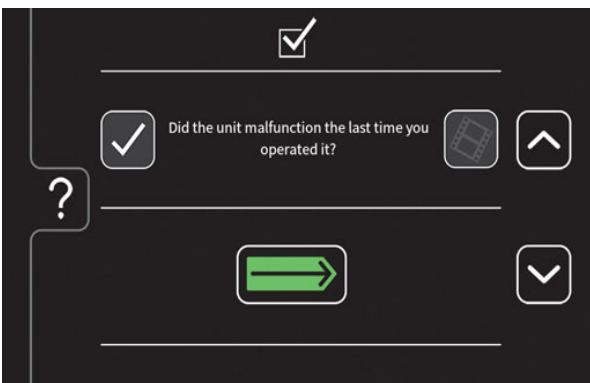
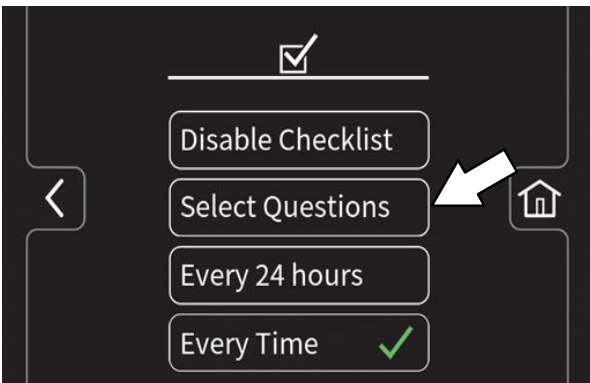

- Press the down arrow button to scroll down through Pre-Operation Checklist items.

- Press the up arrow button to scroll up through Pre-Operation Checklist items.
- Press the check box button to select a new checklist item to add to the checklist.
- Press either the video help button to view the video related to a particular Pre-Operation Checklist item.
- Press the Enter button to add the selected Pre-Operation Checklist item(s) to the Pre-Operation Checklist.
- Press the help button to access the Pre-Operation Checklist help screen.

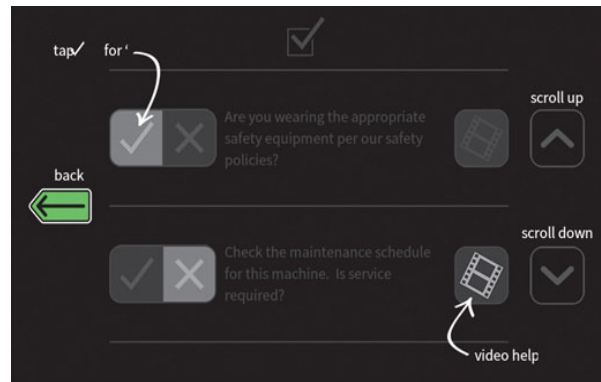

- Press the back button to return to the Pre-Operation Checklist Master List screen.

4. Press the Every 24 hours button or the Every Time button to set the interval the operator must complete the Pre-Operation Checklist. A check mark appears in the chosen interval.

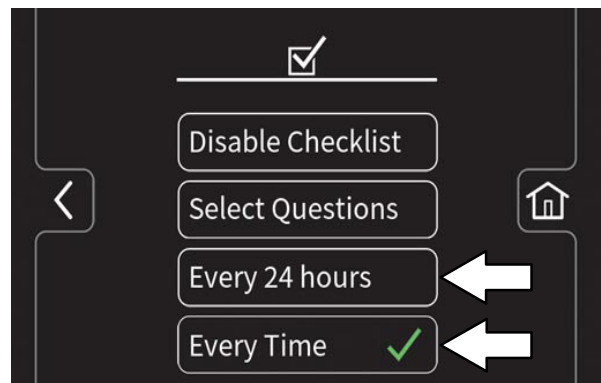

- Press the home button to navigate back to the main operating screen.

- Press the back button to navigate back to the previous screen.

SUPERVISOR CONTROLS

DISABLING / ENABLING THE PRE-OPERATION CHECKLIST

Disabling / enabling the Pre-Operation checklist allows the Pre-Operation checklist to be disabled if it is not necessary for the operator to complete the checklist prior to operating the machine and enabled if it is necessary for the operator to complete the checklist prior to operating the machine.

1. Turn on the machine, login to the main operation screen, and press the setting button to access the supervisor settings screen. See *ENTERING THE SUPERVISOR MODE*.
2. Press the Checklist Setup button to access the Pre-Operation checklist setup screen.

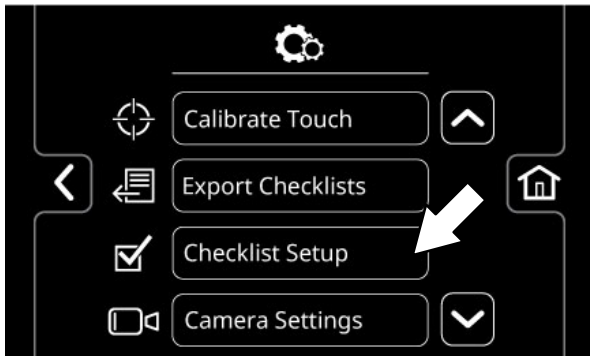

3. Press the Disable Checklist button / Enable Checklist button to disable / enable the Pre-Operation Checklist.

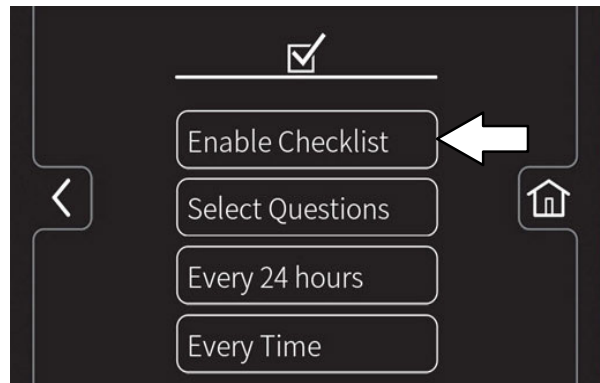
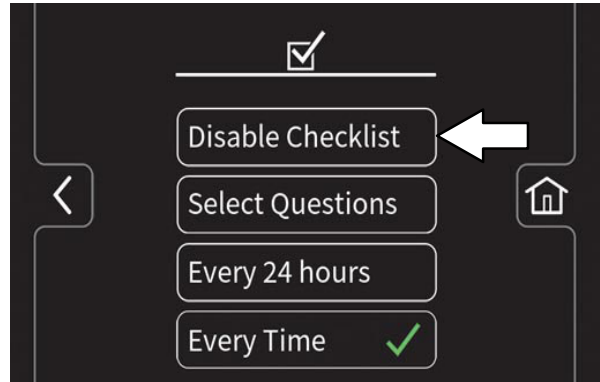

 Press the home button to navigate back to the main operating screen.





 Press the back button to navigate back to the previous screen.

CHANGING THE REAR VIEW CAMERA SETTINGS

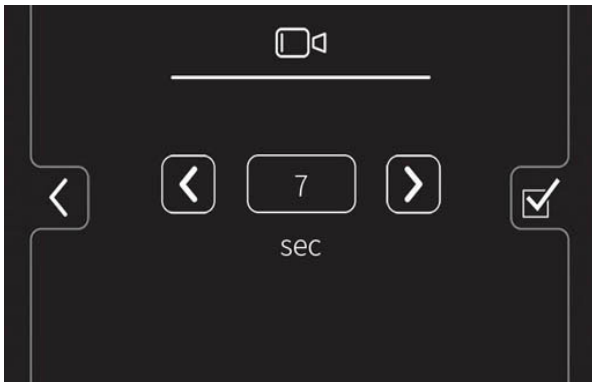
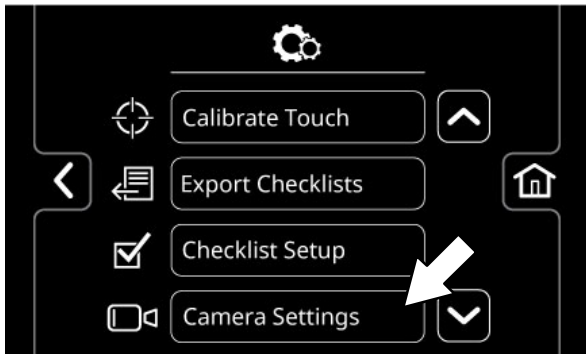
Changing the rear view camera settings allows the time the rear view camera remains on when the *rear view camera button* is pushed to be changed. The rear view camera can be set to any time between 5 seconds and 15 seconds.

1. Turn on the machine, log in to the main operation screen, and press the setting button to access the supervisor settings screen. See *ENTERING THE SUPERVISOR MODE*.
2. Press the *Camera Settings button* to access the rear view camera settings screen.



-  Press the *increase button* to increase the time the rear view camera remains on when the operator presses the *rearview camera button*.
-  Press the *decrease button* to decrease the time the rear view camera remains on when the operator presses the *rearview camera button*.
-  Press the home button to navigate back to the main operating screen.
-  Press the back button to navigate back to the previous screen.

PROGRAMMING THE ZONE CONTROL BUTTONS

Programming the zone control buttons allows the parameters for the zone control buttons to be changed / updated to meet scrubbing / sweeping demands.

1. Turn on the machine, log into the supervisor screen, and press the setting button to access the supervisor settings screen. See *ENTERING THE SUPERVISOR MODE*.
2. Use the *brush pressure increase (+) button* and the *brush pressure decrease (-) button* to set the zone brush pressure.

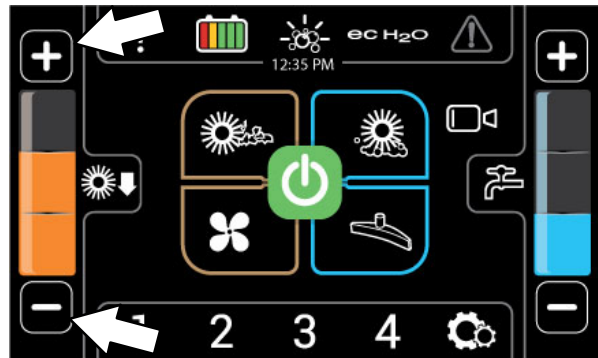

3. Use the *solution increase (+) button* and the *solution decrease (-) button* to set the zone solution flow level.

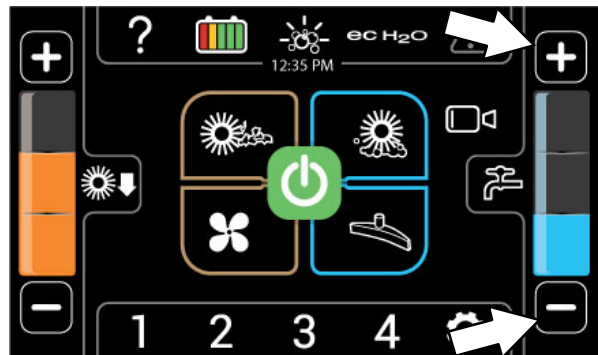

SUPERVISOR CONTROLS

4. Press and hold the zone control button until the “name preset” screen appears.

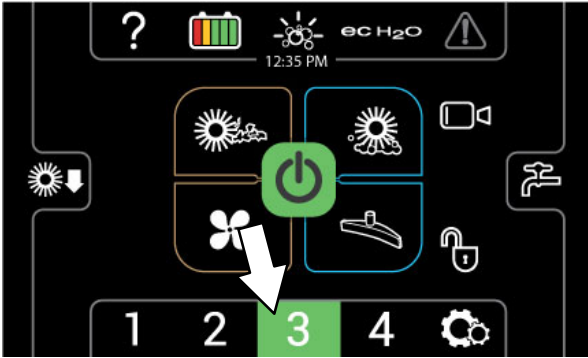



5. Press the yes button to set the zone settings. Press the no button to return to the main operating screen.





6. Use the key pad to enter the name for the zone control button.





 Press the home button to navigate back to the main operating screen.

 Press the back button to navigate back to the previous screen.

 Press the enter button to set the zone button name.

 Press the backspace button if necessary to delete and reenter a number.

 Press the space button to place space between letters / numbers..

 Press the pound button to toggle between the number keypad and the letter keypad.

- Press the enter button to set the zone button settings. The main operating screen returns to the display with the zone button named. The brush pressure and solution flow setting also briefly appear in the display.

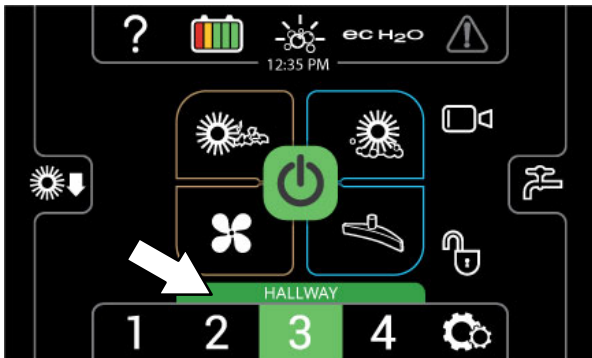

SETTING / CHANGING THE DATE AND TIME

Setting / changing the date and time allow the system date and time to be set / changed.

- Turn on the machine, login to the main operation screen, and press the setting button to access the supervisor settings screen. See *ENTERING THE SUPERVISOR MODE*
- Press the *Date/Time Set button* to access the date / time screen.

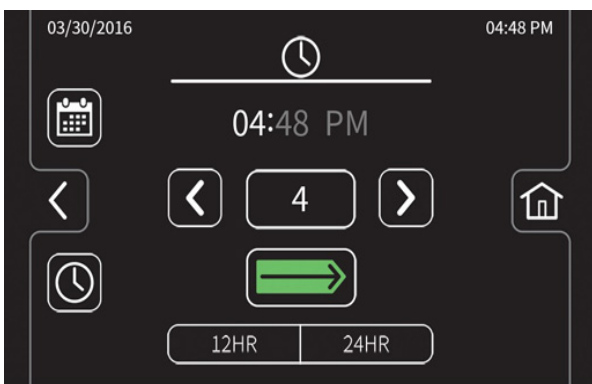
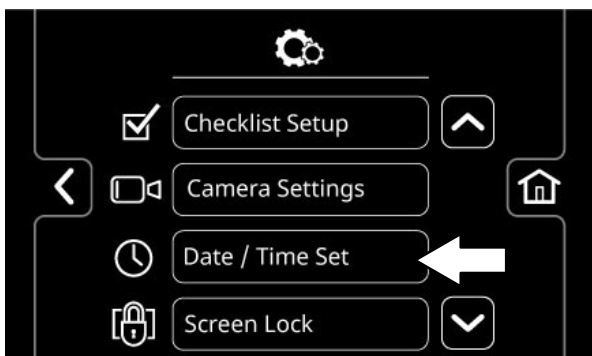

Press the *date button* to change the system date



Press the *time button* to change the system time.



Press the *toggle button* to toggle between hours, minutes, and AM / PM on the time screen and the month, day, and year on the date screen.



Press the *increase button* advance the time / date parameters



Press the *decrease button* to reverse the time / date parameters.



Press the *home button* to navigate back to the main operating screen.



Press the *back button* to navigate back to the previous screen.

- Press the *home button* when finished setting / changing the system date and time to return to the main operating screen.

SETTING / CHANGING THE SCREEN LOCK



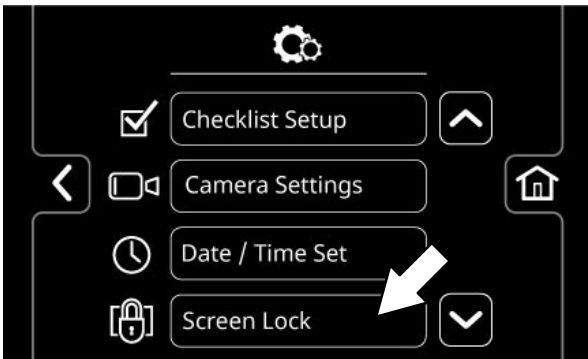

The screen lock setting adjusts the amount of time the screen remains unlocked before going into the screen lock mode during operation.

1. Turn on the machine, login to the main operation screen, and press the setting button to access the supervisor settings screen. See *ENTERING THE SUPERVISOR MODE*
2. Scroll down and press the *Screen Lock button* to access the screen lock screen.

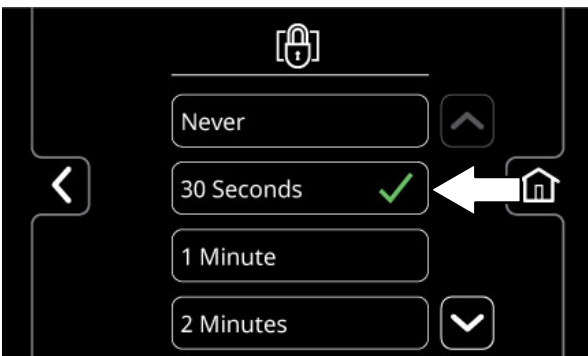

The screen lock delay can be set to never, 30 seconds, or one minute intervals up to 5 minutes.



-  Press the home button to navigate back to the main operating screen.
-  Press the back button to navigate back to the previous screen.
-  Press the down arrow button to scroll down through screen lock times.
-  Press the up arrow button to scroll up through screen lock times.

3. Press the *home button* when finished setting / changing the screen lock time to return to the main operating screen.

