



# Clemas & Co Ltd

Industrial Cleaning Equipment  
Sales - Hire - Service

## TENNANT T3 SCRUBBER DRYER OPERATOR MANUAL



**Clemas & Co.** Unit 16 Ashchurch Business Centre, Alexandra Way,  
Tewkesbury, Gloucestershire, GL20 8NB.

**Tel:** 01684 850777

**Fax:** 01684 850707

**Email:** [info@clemas.co.uk](mailto:info@clemas.co.uk)

**Web:** [www.clemas.co.uk](http://www.clemas.co.uk)

---

**TABLE OF CONTENTS**

---

<b>SAFETY PRECAUTIONS</b> .....	<b>4</b>	<b>DRAINING TANKS</b> .....	<b>13</b>
<b>SAFETY LABELS</b> .....	<b>5</b>	DRAINING RECOVERY TANK .....	13
<b>MACHINE COMPONENTS</b> .....	<b>6</b>	DRAINING SOLUTION TANK .....	14
<b>CONTROL PANEL SYMBOLS</b> .....	<b>6</b>	<b>CHARGING BATTERIES</b> .....	<b>14</b>
<b>MACHINE INSTALLATION</b> .....	<b>7</b>	<b>MACHINE MAINTENANCE</b> .....	<b>16</b>
UNCRATING MACHINE .....	7	DAILY MAINTENANCE .....	16
INSTALLING BATTERIES .....	7	MONTHLY MAINTENANCE .....	17
<b>HOW THE MACHINE WORKS</b> .....	<b>8</b>	QUARTERLY MAINTENANCE .....	18
<b>MACHINE SETUP</b> .....	<b>8</b>	ANNUAL MAINTENANCE .....	18
ATTACHING SQUEEGEE ASSEMBLY .....	8	SQUEEGEE BLADE REPLACEMENT .....	18
INSTALLING BRUSHES/PADS .....	8	SQUEEGEE BLADE ADJUSTMENT .....	19
INSTALLING FaST-PAK .....	9	BATTERY MAINTENANCE .....	19
FILLING SOLUTION TANK .....	10	BRUSH MOTOR BELT REPLACEMENT (50 cm DUAL DISK MODEL) .....	20
<b>MACHINE OPERATION</b> .....	<b>10</b>	<b>TRANSPORTING MACHINE</b> .....	<b>21</b>
PRE-OPERATION CHECKS .....	10	<b>STORING MACHINE</b> .....	<b>21</b>
OPERATING THE MACHINE .....	10	FaST SYSTEM FREEZE PROTECTION .....	22
EMERGENCY STOPPING (DRIVE MODEL) WHILE OPERATING MACHINE .....	12	<b>RECOMMENDED STOCK ITEMS</b> .....	<b>22</b>
BATTERY METER .....	12	<b>TROUBLESHOOTING</b> .....	<b>23</b>
CIRCUIT BREAKER / FUSES .....	13	<b>LED FAULT CODES</b> .....	<b>24</b>
HOUR METER .....	13	<b>SPECIFICATIONS</b> .....	<b>25</b>

---

## **SAFETY PRECAUTIONS**

---

This machine is intended for commercial use. It is designed exclusively to scrub hard floors in an indoor environment and is not constructed for any other use. Only use recommended pads, brushes and commercially approved floor cleaners intended for machine application.

All operators must read, understand and practice the following safety precautions.

The following warning alert symbol and the "FOR SAFETY" heading are used throughout this manual as indicated in their description:

 **WARNING:** To warn of hazards or unsafe practices which could result in severe personal injury or death.

**FOR SAFETY:** To identify actions which must be followed for safe operation of equipment.

---

Failure to follow these warnings may result in personal injury, electrical shock, fire or explosion.

 **WARNING:** Fire Or Explosion Hazard:

- **Never Use Flammable Liquids Or Operate Machine in Or Near Flammable Liquids, Vapors Or Combustible Dusts.**

*This machine is not equipped with explosion proof motors. The electric motors will spark upon start up and during operation which could cause a flash fire or explosion if machine is used in an area where flammable vapors/liquids or combustible dusts are present.*

- **Do Not Pick Up Flammable Materials Or Reactive Metals.**
- **Batteries Emit Hydrogen Gas. Keep Sparks And Open Flame Away. Keep Battery Compartment Open When Charging.**

 **WARNING:** Electrical Hazard. Disconnect Battery Cables Before Servicing Machine.

 **WARNING:** Spinning Brush. Keep Hands Away. Turn Off Power Before Working On Machine.

The following information signals potentially dangerous conditions to the operator or equipment:

**FOR SAFETY:**

1. **Do not operate machine:**
  - With flammable liquids or near flammable vapors as an explosion or flash fire may occur.
  - Unless trained and authorized.
  - Unless operator manual is read and understood.
  - If not in proper operating condition.
2. **Before starting machine:**
  - Make sure all safety devices are in place and operate properly.
3. **When using machine:**
  - Go slow on inclines and slippery surfaces.
  - Wear non-slip shoes.
  - Reduce speed when turning.
  - Report machine damage or faulty operation immediately.
  - Never allow children to play on or around.
  - Follow mixing and handling instructions on chemical containers.
4. **Before leaving or servicing machine:**
  - Stop on level surface.
  - Turn off machine.
  - Set parking brake.
  - Remove key.
5. **When servicing machine:**
  - Avoid moving parts. Do not wear loose jackets, shirts, or sleeves.
  - Disconnect battery connections before working on machine.
  - Wear protective gloves and eye protection when handling batteries or battery cables.
  - Avoid contact with battery acid.
  - Do not power spray or hose off machine. Electrical malfunction may occur.
  - Use manufacturer supplied or approved replacement parts.
  - All repairs must be performed by a qualified service person.
  - Do not modify the machine from its original design.

**6. When transporting machine:**

- Turn machine off.
- Do not lift machine when batteries are installed.
- Get assistance when lifting machine.
- Use a recommended ramp when loading/unloading into/off truck or trailer.
- Use tie-down straps to secure machine to truck or trailer.
- Put scrub head in the lowered position.
- Set parking brake.

**SAFETY LABELS**

The safety labels appear on the machine in the locations indicated. Replace labels if they are missing or become damaged or illegible.

**BATTERY CHARGE LABEL -**

Located on bottom side of recovery tank.

**⚠ WARNING: Fire Or Explosion Hazard. Batteries Emit Hydrogen Gas. Keep Sparks And Open Flame Away. Keep Battery Compartment Open When Charging.**

**SPINNING BRUSH LABEL -**

Located on scrub head





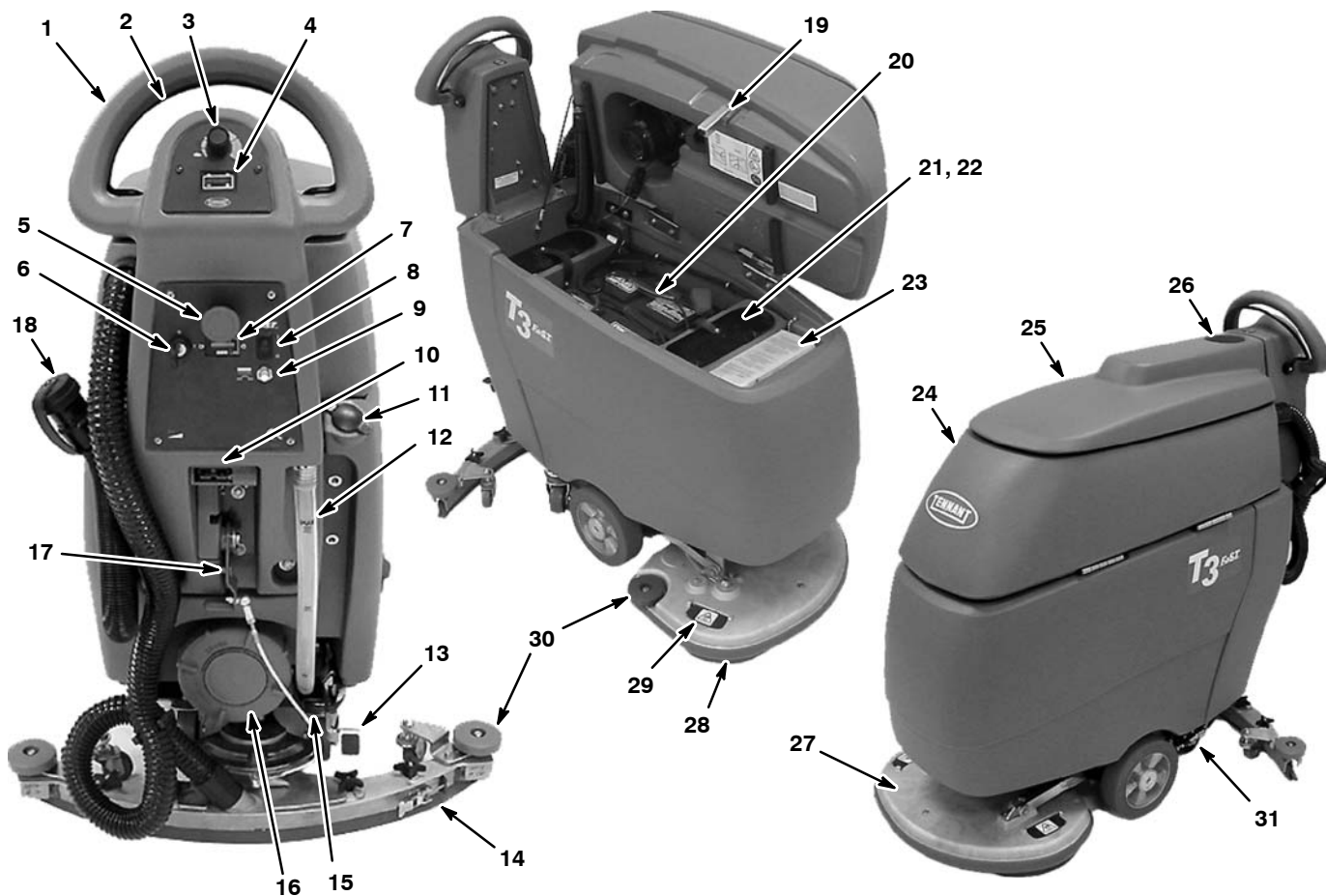



**⚠ WARNING: Spinning Brush. Keep Hands Away. Turn Off Power Before Working On Machine.**

**MACHINE COMPONENTS**



- |   |                                       |
|---|---------------------------------------|
| 1. Control Handle                         | 17. Squeegee Lift Lever               |
| 2. Control Handle Start Bail              | 18. Recovery Tank Drain Hose          |
| 3. Speed Control Knob (drive model)       | 19. Recovery Tank Support Stand       |
| 4. Battery Meter                          | 20. Batteries                         |
| 5. Emergency Stop Button (drive model)    | 21. Solution Tank                     |
| 6. Main Power Key Switch                  | 22. Bucket Fill Port/Clean-out Port   |
| 7. Hour Meter                             | 23. FaST-PAK Concentrate (FaST Model) |
| 8. FaST System On/Off Switch (FaST Model) | 24. Recovery Tank                     |
| 9. Brush Motor Circuit Breaker Button     | 25. Recovery Tank Cover               |
| 10. Battery Charge Receptacle             | 26. Cup Holder                        |
| 11. Hose Fill-Port                        | 27. Scrub Head                        |
| 12. Solution Tank Level/Drain Hose        | 28. Pad/Brush                         |
| 13. Scrub Head Lift Pedal                 | 29. Pad Driver Window                 |
| 14. Squeegee Assembly                     | 30. Wall Rollers                      |
| 15. Solution Flow Control Knob            | 31. Parking Brake                     |
| 16. Solution Tank Clean-Out Port          |                                       |

**CONTROL PANEL SYMBOLS**

	Main Power I/O Key Switch		FaST System I/O Switch (FaST Model)		5% (3°) Maximum Machine Climb
	Slow Speed		Brush Motor Circuit Breaker		Solution Flow Control
	Fast Speed		Bail Direction		Parking Brake

## MACHINE INSTALLATION

### UNCRATING MACHINE

1. Carefully check the shipping crate for signs of damage. Report damages at once to carrier.
2. Check the contents list. Contact distributor for missing items.

Contents:

- 2-12 V Batteries-Optional
- Battery Charger-Optional
- 2-Foam Battery Spacers (#630375)
- Battery Tray (#1012994)
- 38 cm Battery Cable (#1011749)
- 1-FaST-PAK 365 Concentrate (#999005) (FaST Model)
- Squeegee Assembly

*Pad drivers, brushes and pads must be purchased separately.*

3. To uncrate your machine, remove the shipping hardware and straps that secure the machine to the pallet. With assistance, carefully lift the machine off the pallet.

**ATTENTION: Do not roll machine off pallet unless a ramp is used, machine damage may occur.**

**ATTENTION: To prevent possible machine damage, install batteries after removing machine from shipping pallet.**

### INSTALLING BATTERIES

**⚠ WARNING: Fire Or Explosion Hazard. Batteries Emit Hydrogen Gas. Keep Sparks And Open Flame Away. Keep Battery Hood Open When Charging.**

**FOR SAFETY: When servicing machine, wear protective gloves and eye protection when handling batteries and battery cables. Avoid contact with battery acid.**

#### Battery Specifications:

Two 12 volt, 100 AH-Maintenance Free deep cycle batteries. Maximum battery dimensions: 174 mm W x 380 mm L x 284 mm H.

1. Park the machine on a level surface, remove the key and set parking brake.
2. Lift the recovery tank to access the battery compartment. Remove the loose battery cable from the compartment (Figure 1).



FIG. 1

3. Carefully install the batteries into the battery compartment tray and arrange the battery posts as shown (Figure 2). Insert the two foam spacers in front of the batteries as shown.

**ATTENTION: Do not drop the batteries into the compartment, battery and machine housing damage may result.**

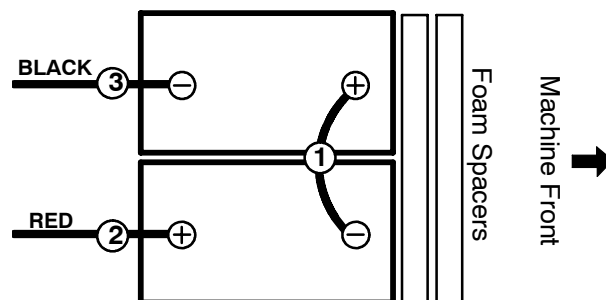
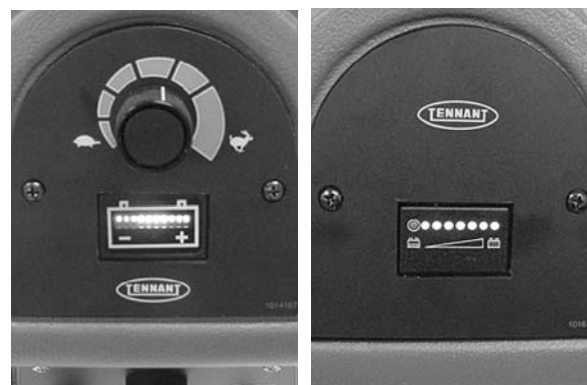

FIG. 2

4. Before connecting the battery cables, make sure the terminals and posts are clean. Use a post cleaner and wire brush if necessary.

**NOTE: Apply a light coating of non-metallic grease or protective spray on the cable connections to prevent battery corrosion.**

5. Connect the cables to the battery posts in numerical order as labeled (Figure 2), RED TO POSITIVE (+) & BLACK TO NEGATIVE (-).
6. After installing the batteries, check the battery meter charge level (Figure 3). Charge batteries if needed. (See BATTERY METER on page 13 for further details)



50 cm Drive Model

43 cm Push Model

FIG. 3

---

## HOW THE MACHINE WORKS

---

### Conventional Scrubbing (Standard Model):

Water and detergent from the solution tank flow to the floor through a manually controlled solution valve. The brush uses the detergent and water solution to scrub the floor clean. As the machine moves forward, the squeegee wipes the dirty solution from the floor into the recovery tank.

### Foam Scrubbing (FaST Model):

#### (FaST-Foam Scrubbing Technology)

Unlike conventional scrubbing, the FaST system injects the patented FaST-PAK concentrate formula with a small amount of water and air onto the floor. The mixture creates a large volume of expanded wet foam for the brush to scrub the floor clean. As the machine moves forward, the foam collapses and the squeegee wipes the dirty solution into the the recovery tank leaving the floor completely dry and slip free.

The foam scrubbing application (FaST) can increase productivity by 30% by reducing the dump/fill cycle. It will also reduce chemical usage and storage space. One FaST-PAK can scrub up to 90,000 sq. meters.

**NOTE:** The FaST model can also be operated as a conventional scrubber. However, it's important that you follow the instructions in this manual to prevent FaST system failure.

---

## MACHINE SETUP

---

### ATTACHING SQUEEGEE ASSEMBLY

1. Park the machine on a level surface, remove the key and set the parking brake.
2. Lift the squeegee lift lever to the upward position (Figure 4).



FIG. 4

3. Mount the squeegee assembly to the squeegee pivot bracket as shown (Figure 5). Make sure the knobs are completely seated into the slots before securing knobs.

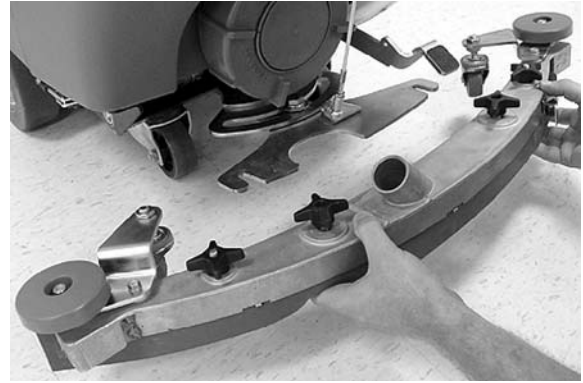

FIG. 5

4. Connect the vacuum hose to the squeegee assembly. Loop the hose as shown using the hose clip provided (Figure 6).

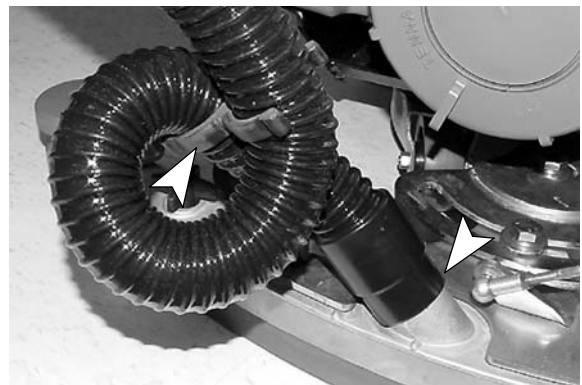

FIG. 6

5. Check the squeegee blades for proper adjustment (See SQUEEGEE BLADE ADJUSTMENT).

---

### INSTALLING BRUSHES/PADS

**NOTE:** Consult your authorized distributor for pad and brush recommendations.

1. Park the machine on a level surface, remove the key and set the parking brake.
2. Step down on the scrub head lift pedal to raise the scrub head off the floor (Figure 7).



FIG. 7

3. Attach the pad to the pad driver before installing the driver. Make sure the pad is centered on the driver (Figure 8). Secure pad with centerlock (43 cm Single Disk Model only).

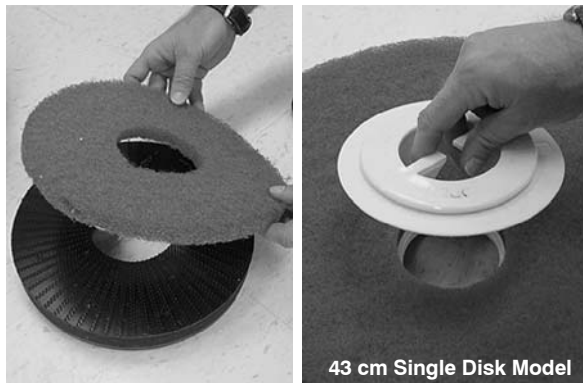

FIG. 8

4. Align the pad driver mounting studs into the motor hub slots and give the pad driver a quick turn to engage spring clip (Figure 9).

**NOTE:** For the 50 cm dual disk model, the left and right pad drivers engage the spring clip in opposite directions.

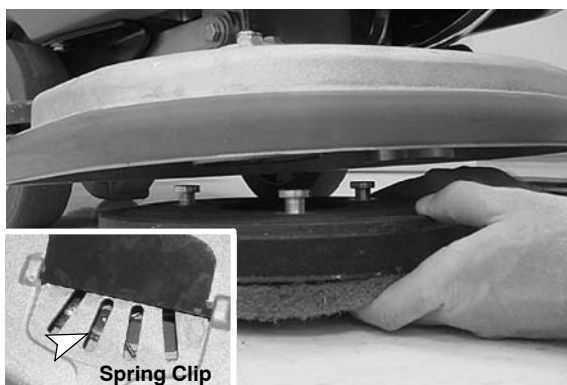

FIG. 9

5. To remove the pad driver, grip the driver and give it a quick turn away from the spring clip.

### INSTALLING FaST-PAK (FaST Model)

*FaST 365 Floor Cleaning Concentrate (#999005)*

**ATTENTION: The FaST-PAK Concentrate Formula is specifically designed for the FaST system. NEVER use a substitute, machine damage may result.**

1. Remove the perforated knock-out from the FaST-PAK carton. Do not remove the bag from the carton. Pull the hose connector through the knock-out and remove the orange cap (Figure 10).

**FOR SAFETY: When using machine, always follow the handling instructions on chemical container.**



FIG. 10

2. Lift the recovery tank to access the FaST-PAK compartment. Connect the supply hose to the FaST-PAK and place the FaST-PAK carton into the compartment as shown (Figure 11). Make sure that the supply hose doesn't get kinked or pinched.

**NOTE:** If any dried concentrate is visible on the supply hose connector or on the FaST-PAK connector, soak and clean with warm water.



FIG. 11

3. When the supply hose is not in use, make sure to connect it to the storage plug (Figure 12). This will prevent the FaST system from drying out and clogging up the supply hose.

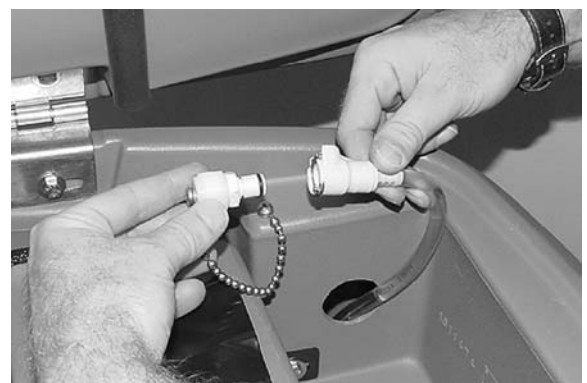

FIG. 12



**FILLING SOLUTION TANK**

The machine is equipped with a hose fill-port at the rear of the machine, and a bucket fill-port located under the recovery tank (Figure 13). Before accessing the bucket fill-port make sure that the recovery tank is empty.

Fill the solution tank to the “40 L MAX” level mark on the solution tank drain hose. When using the bucket fill-port, stop filling when the level reaches the bottom edge of the fill-port (Figure 13).

**FOR FOAM SCRUBBING (FaST Model) : ONLY FILL TANK WITH CLEAN COOL WATER (< 21°C).**

**NOTE:** DO NOT use hot water or add any conventional floor cleaning detergents, FaST system failure may result.

**FOR CONVENTIONAL SCRUBBING:** Fill tank with water (60°C maximum). Pour a recommended cleaning detergent into the solution tank according to mixing instructions on the bottle.



FIG. 13

**NOTE:** When filling the solution tank with a bucket, make sure that the bucket is clean. Do not use the same bucket for filling and draining the machine.

**ATTENTION:** For Conventional Scrubbing, only use recommended cleaning detergents. Machine damage due to improper detergent usage will void the manufacturer’s warranty.

**WARNING:** Fire or Explosion Hazard. Never Use Flammable Liquids.

**FOR SAFETY:** When using machine, follow mixing and handling instructions on chemical containers.

**MACHINE OPERATION**

**FOR SAFETY:** Do not operate machine, unless operator manual is read and understood.

**WARNING:** Fire Or Explosion Hazard. Never Operate Machine In Or Near Flammable Liquids, Vapors Or Combustible Dusts.

FIRST TIME USE (FaST Model): The FaST system is protected against freezing during shipment. You must operate the FaST system for 10 minutes to disperse the mixture of RV anti-freeze/FaST concentrate before achieving maximum foam.

**PRE-OPERATION CHECKS**

1. Sweep and dust-mop the floor.
2. Check the battery meter charge level (See BATTERY METER).
3. Check the pad(s)/brush(es) for wear.
4. Check the squeegee blades for wear and proper adjustment.
5. Make sure the recovery tank is empty and the float shut-off screen is installed and clean.
6. 43cm Single Disk Model: Check the scrub head skirt for wear.
7. Foam scrubbing (FaST Model): Check the FaST-PAK concentrate level.
8. Foam scrubbing (FaST Model): Make sure the solution tank is filled with only cool clean water, no detergents.

**OPERATING THE MACHINE**

1. Release the parking brake (Figure 14).
2. Turn the main power key switch to the on ( I ) position (Figure 14).

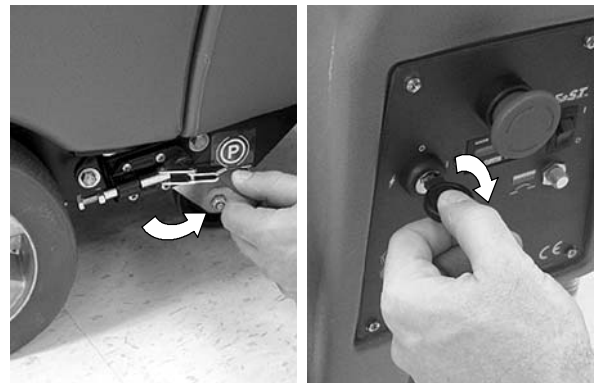

FIG. 14

3. FaST Model: To foam scrub, press the FaST system switch to the on ( I ) position (Figure 15).

**NOTE:** When using the FaST model for conventional scrubbing DO NOT turn the FaST system switch on. Conventional cleaning detergents/restorers may cause failure to the FaST injection system. Drain, rinse and refill solution tank with cool clean water before operating the FaST system.



FIG. 15

4. Lower the squeegee assembly to floor by lowering the squeegee lift lever (Figure 16). The vacuum motor will automatically turn on.

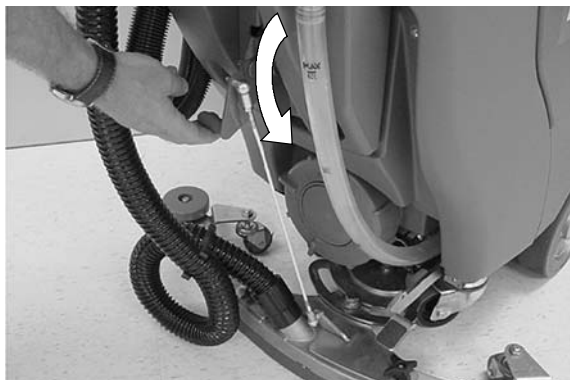

FIG. 16

5. Lower the scrub head to the floor by stepping on the scrub head lift pedal as shown (Figure 17).

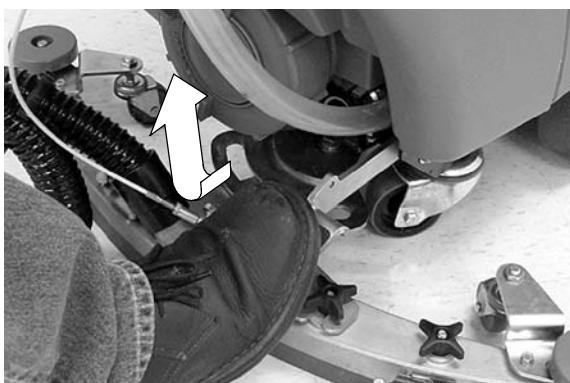

FIG. 17

6. Pull the control handle bail backwards to start scrubbing (Figure 18). The drive model will automatically propel forward. To reverse the drive model, simply push the control handle bail forward.

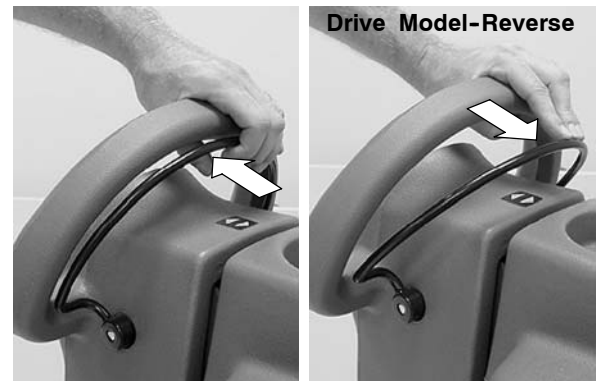

FIG. 18

7. Drive Model: Adjust the speed control knob to a desired scrubbing speed (Figure 19).

**NOTE:** 45-60 meters per minute is the recommended scrubbing speed.



FIG. 19

8. For conventional scrubbing, turn the solution flow control knob to a desired flow rate (Figure 20).

**NOTE:** FaST Model - When using the FaST system, the solution flow control knob is nonfunctional. The FaST system has a set solution flow rate.

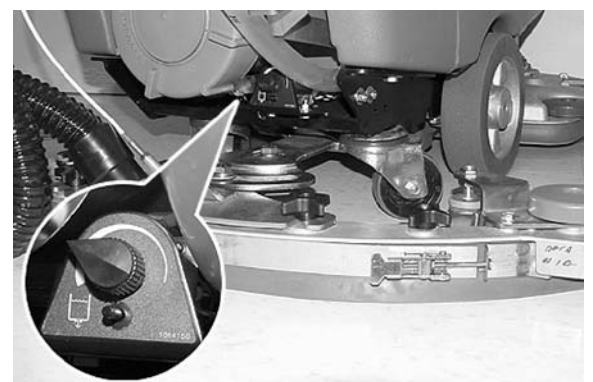
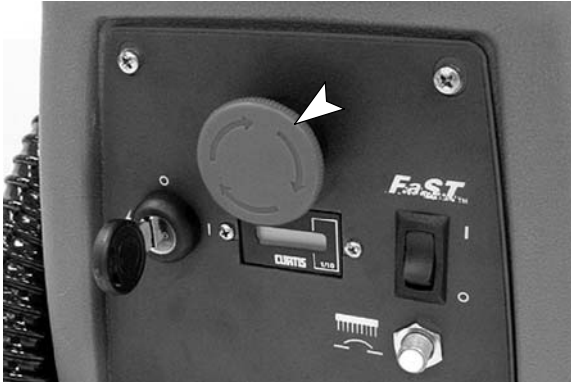

FIG. 20

9. To stop scrubbing, release the control handle bail, raise the scrub head and the squeegee.

**EMERGENCY STOPPING (Drive Model)**

Strike the emergency-stop button, located on the control panel, to stop the machine in an emergency. Turn the button clockwise to reset (Figure 21).



**FIG. 21**

**WHILE OPERATING MACHINE**

**⚠ WARNING: Fire Or Explosion Hazard. Do Not Pick Up Flammable Materials Or Reactive Metals.**

1. Overlap each scrubbing path by 5 cm.
2. Keep the machine moving to prevent damage to floor finish.
3. Wipe the squeegee blades with a cloth if blades leave streaks. Pre-sweep the area to prevent streaking.
4. Do not operate the machine on inclines that exceed 5% (3°).

**FOR SAFETY: When using machine, go slow on inclines and slippery surfaces.**

5. Conventional scrubbing: Pour a recommended foam control solution into the recovery tank if excessive foam appears.

**ATTENTION: Do not allow foam to enter the float shut-off screen, vacuum motor damage will result. Foam will not activate the float shut-off screen.**

6. Use the double scrubbing method for heavily soiled areas. First scrub the area with the squeegee up, let solution set for 3-5 minutes, then scrub the area a second time with squeegee down.
7. Change or rotate pads as needed.
8. Observe the battery meter discharge level (See BATTERY METER).
9. Observe the solution tank level hose for remaining solution. 10 liters will last approximately 10 minutes during conventional scrubbing and 20 minutes during foam scrubbing with the FaST Model.
10. When the solution tank runs dry, empty the recovery tank before refilling.

11. When leaving the machine unattended, remove the key and set the parking brake.
12. Perform the Daily Maintenance procedures after scrubbing (See MACHINE MAINTENANCE).

**BATTERY METER**

The battery meter displays the charge level of the batteries. When the batteries are fully charged, all indicator lights are lit. As the batteries discharge, the indicator lights will begin to go out from right to left. To prolong the life of the batteries, do not allow the indicator lights to go beyond the discharge level as described below.

**NOTE: ONLY recharge the batteries when the machine is used for a total of 30 minutes or more.**

**DRIVE MODEL BATTERY METER:** When the discharge level reaches the first red light, stop scrubbing and recharge the batteries (Figure 22). If the last red light begins to flash, the scrubbing function will shut off automatically. This protects the batteries from total discharge. Drive the machine to the charging area and recharge the batteries immediately.

**NOTE: The Drive Model battery meter also displays machine fault codes. If a fault is detected the LED bars will flash specific fault codes (See LED FAULT CODES).**



**FIG. 22**

**PUSH MODEL BATTERY METER:** When the discharge level reaches the last yellow light, the light will begin to flash, stop scrubbing and recharge the batteries (Figure 23). If the red light appears, the scrubbing function will shut off automatically. This protects the batteries from total discharge. Recharge the batteries immediately.



FIG. 23

### CIRCUIT BREAKER / FUSES

The machine is equipped with a resettable circuit breaker to protect the brush motor from damage. The circuit breaker button is located on the control panel (Figure 24). If the circuit breaker should trip, determine the cause, allow the motor to cool, and then manually reset the circuit breaker button.

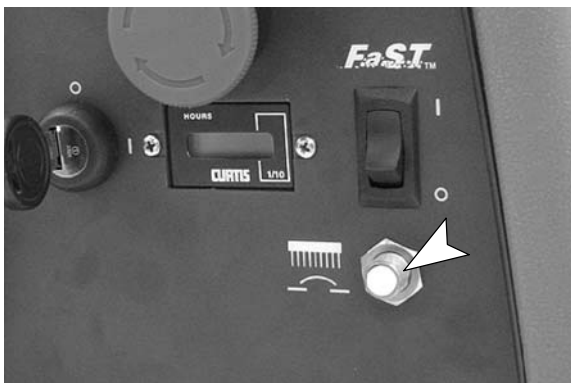

FIG. 24

### HOUR METER

The hour meter records the number of total hours the brush motor has been powered on. Use the hour meter to determine when to perform recommended maintenance procedures and to record service history (Figure 25).

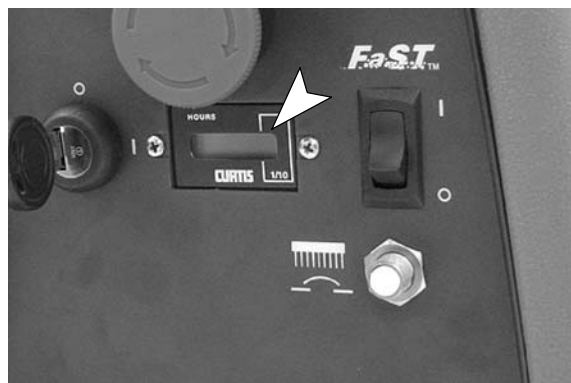

FIG. 25

## DRAINING TANKS

The recovery tank should be drained and cleaned out after every use. The solution tank should be cleaned out periodically to remove any corrosion.

Transport the machine to a draining site, turn the key off and follow the draining instructions below:

**FOR SAFETY: Before leaving or servicing machine, stop on level surface, turn off machine and remove key.**

### DRAINING RECOVERY TANK

1. Remove the recovery tank drain hose cap by turning it counter-clockwise and drain the tank (Figure 26).

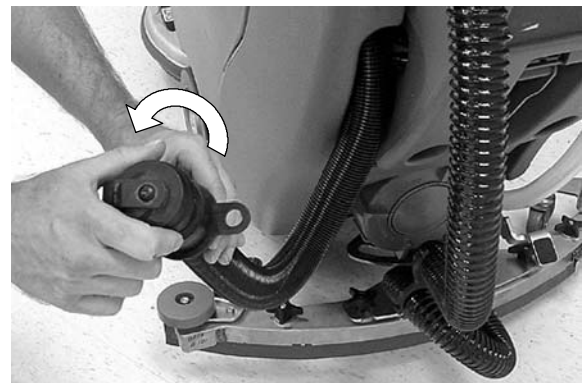

FIG. 26

**NOTE:** When using a bucket to drain the machine, do not use the same bucket to fill the solution tank.

2. Open the recovery tank cover and rinse out the tank. Use a rag to remove any excess dirt (Figure 27).



FIG. 27

3. Remove and clean the float shut-off screen located in the recovery tank (Figure 28).



FIG. 28

**DRAINING SOLUTION TANK**

1. To drain any remaining water from the solution tank, pull the solution tank level hose off the hose fitting as shown (Figure 29).

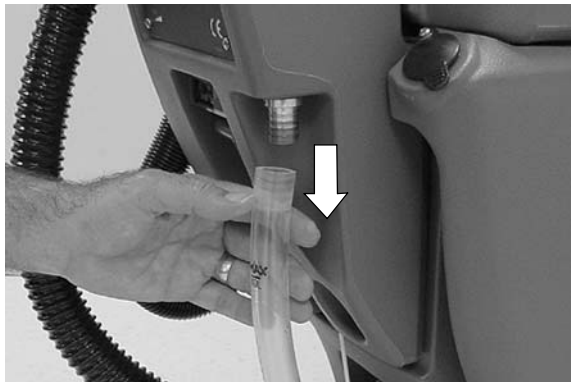

FIG. 29

2. To rinse out the solution tank, remove the clean-out cap at the rear of the machine and spray water (60°C maximum) directly into the two fill-ports located under the recovery tank (Figure 30).

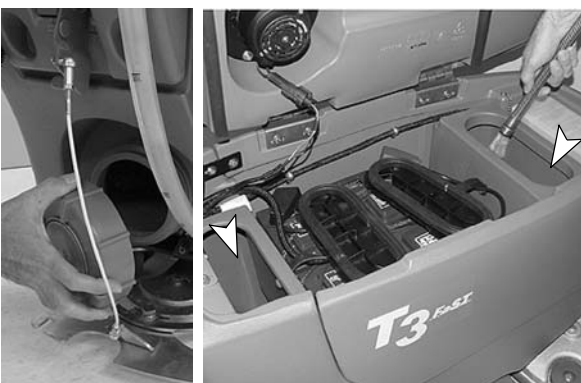

FIG. 30

3. Remove and clean the solution tank filter (Figure 31). Turn the filter counter-clockwise to remove.



FIG. 31

4. After rinsing out the tank, securely replace the solution tank filter, clean-out cap, fill-port covers and hose.

**CHARGING BATTERIES**

**ATTENTION: To prolong the life of the batteries and to provide optimum machine performance, ONLY recharge the batteries after a total of 30 minutes of use or more. Do not leave batteries discharged for lengthy periods.**

The following charging instructions are intended for battery chargers supplied with the machine. Only use a battery charger with the following specifications to prevent battery damage.

**BATTERY CHARGER SPECIFICATIONS:**

- CHARGER TYPE:
  - FOR MAINTENANCE FREE BATTERIES OR
  - FOR LEAD ACID BATTERIES
- OUTPUT VOLTAGE - 24 VOLTS
- OUTPUT CURRENT - 15 AMPS
- AUTOMATIC SHUTOFF CIRCUIT
- FOR DEEP CYCLE BATTERY CHARGING

1. Transport the machine to a well-ventilated area for charging.

**⚠ WARNING: Fire Or Explosion Hazard. Batteries Emit Hydrogen Gas. Keep Sparks And Open Flame Away. Keep Battery Compartment Open When Charging.**

2. Park the machine on a level surface, turn the key off and set the parking brake.

- Lead Acid Batteries: Before charging the batteries, check the electrolyte level in each battery cell (Figure 32).



FIG. 32

**FOR SAFETY: When servicing machine, wear protective gloves and eye protection when handling batteries and battery cables. Avoid contact with battery acid.**

The electrolyte level (A) should slightly cover the battery plates (B). Add distilled water as needed. DO NOT OVERFILL, the fluid may expand and overflow while charging. Replace cell caps before charging (Figure 33).

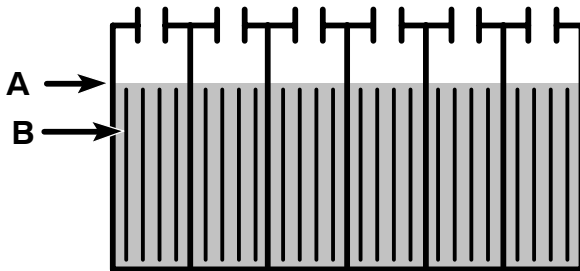

FIG. 33

- Rest the recovery tank on the support stand to promote ventilation during charging (Figure 34).

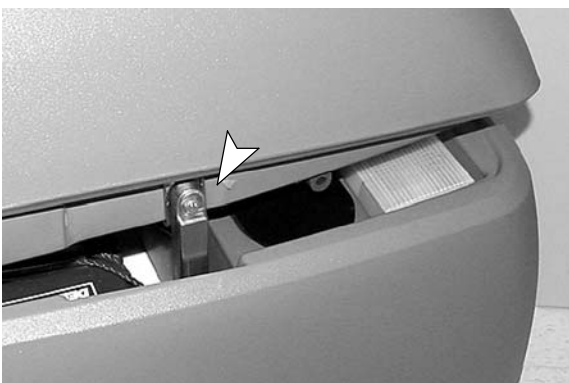

FIG. 34

- Connect the charger's AC power supply cord to a properly grounded receptacle (Figure 35).

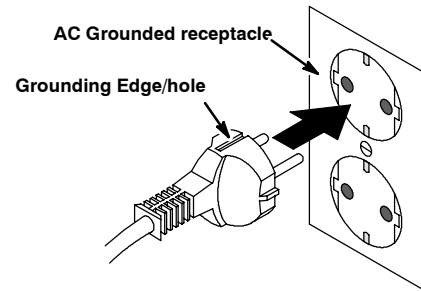

FIG. 35

- Connect the charger's DC cord to the machine's battery receptacle at the rear of the machine (Figure 36).

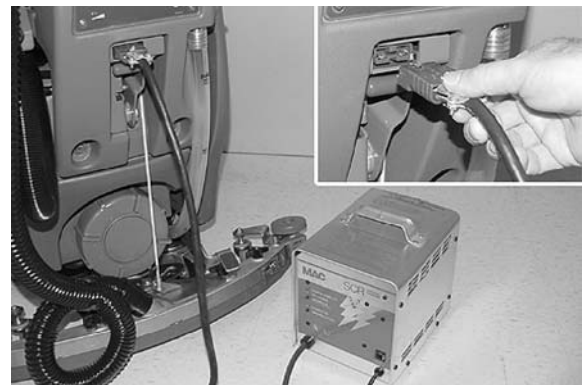

FIG. 36

- The charger will automatically begin charging and shut off when fully charged.

**NOTE:** The machine will not operate once the battery charger is connected.

**ATTENTION:** Do not disconnect the charger's DC cord from the machine's receptacle when the charger is operating. Arcing may result. If the charger must be interrupted during charging, disconnect the AC power supply cord first.

**⚠ WARNING: Fire Or Explosion Hazard. Batteries Emit Hydrogen Gas. Keep Sparks And Open Flame Away. Keep Battery Compartment Open When Charging.**

- Lead Acid Batteries: After charging, check the electrolyte level (A) again. The level should be approximately 1 cm from the bottom of the fill-port (B) (Figure 37). Add distilled water if needed. DO NOT OVERFILL.

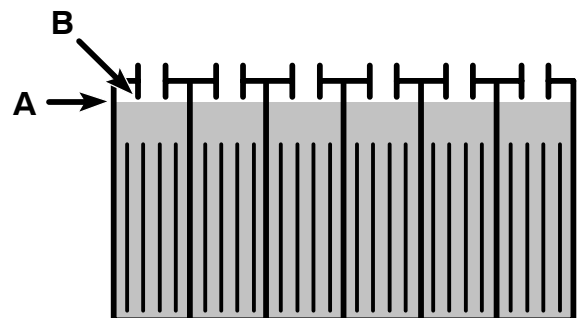

FIG. 37

**MACHINE MAINTENANCE**

To keep the machine in good working condition, simply follow the daily, monthly and quarterly maintenance procedures.

**⚠ WARNING: Electrical Hazard. Disconnect Battery Cables Before Servicing Machine.**

**DAILY MAINTENANCE**

1. Drain and clean out the recovery tank (Figure 38).



**FIG. 38**

2. Remove and clean the float shut-off screen located in the recovery tank (Figure 39).



**FIG. 39**

3. Drain the solution tank and rinse out the inside with water (60°C maximum) as needed (Figure 40).

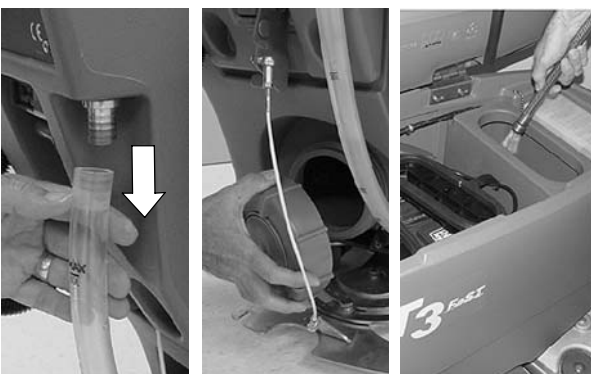

**FIG. 40**

4. Remove and clean the solution tank filter (Figure 41). Turn the filter counter-clockwise to remove.



**FIG. 41**

5. Remove the pad(s)/brush(es) and clean. Rotate pad or replace when worn (Figure 42).



**FIG. 42**

6. Wipe the squeegee blades clean (Figure 43). Store the squeegee assembly in the raised position to prevent blade damage.

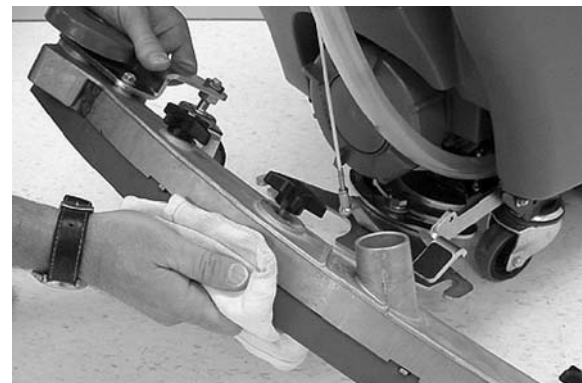

**FIG. 43**

7. Check the condition of the squeegee blade wiping edge (Figure 44). Rotate blade if worn. (See SQUEEGEE BLADE REPLACEMENT)

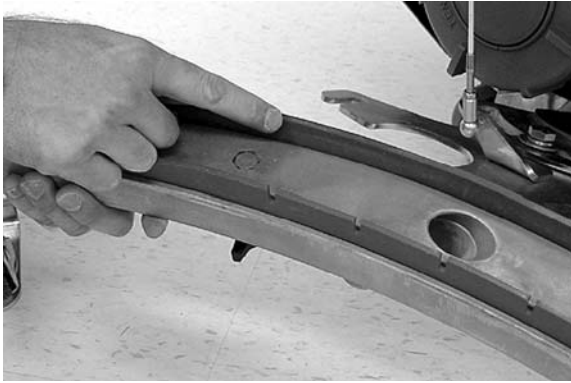

FIG. 44

8. Clean the machine with an all purpose cleaner and damp cloth (Figure 45).

**FOR SAFETY: When cleaning machine, do not power spray or hose off machine. Electrical malfunction may occur.**



FIG. 45

9. 43 cm Single Disk Model: Inspect the condition of the scrub head skirt, replace if worn or damaged (Figure 46).



FIG. 46

10. FaST Model: Connect the FaST-PAK supply hose to the storage plug when not it use (Figure 47). Remove any dried concentrate from the hose connector by soaking it in warm water.



FIG. 47

11. Recharge the batteries after a total of 30 minutes of use or more (Figure 48). (See CHARGING BATTERIES).

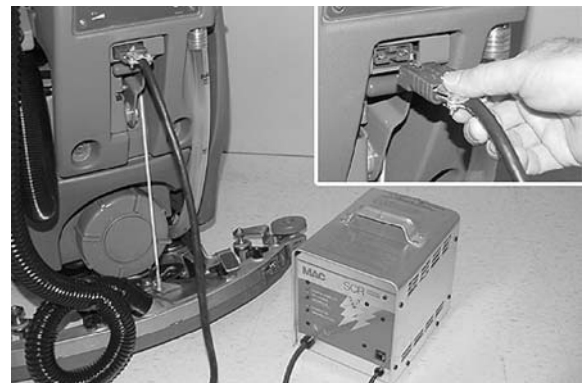

FIG. 48

## MONTHLY MAINTENANCE

1. Lead Acid Batteries: Clean the battery tops to prevent corrosion (See BATTERY MAINTENANCE).
2. Check for loose battery cable connections.
3. Inspect and clean the recovery tank cover seal (Figure 49). Replace if damaged.



FIG. 49

4. Lubricate all pivot points and rollers with silicone spray then coat with a water resistant grease to maintain smooth operation.



5. Clean the parking brake clamp with a cleaning solvent.
6. Check the machine for loose nuts and bolts.
7. Check the machine for leaks.

**QUARTERLY MAINTENANCE**

Every 250 hours, check the drive transaxle motor (50 cm model), the vacuum motor and the brush motor for carbon brush wear. Replace carbon brushes when worn to a length of 10 mm or less.

**Contact an Authorized Service Center for machine repairs.**

**⚠ WARNING: Electrical Hazard. Disconnect Battery Cables Before Servicing Machine.**

**ANNUAL MAINTENANCE  
(Every 1000 hours of use)**

**FaST Model Only:**

Clean or replace the orifice plate and filter screen located inside the solution injector assembly. Order service kit p/n 9001489.

1. To access the orifice plate and filter, lower the scrub head. Remove the injector assembly from the clamps located behind the front edge of the machine (Figure 50).

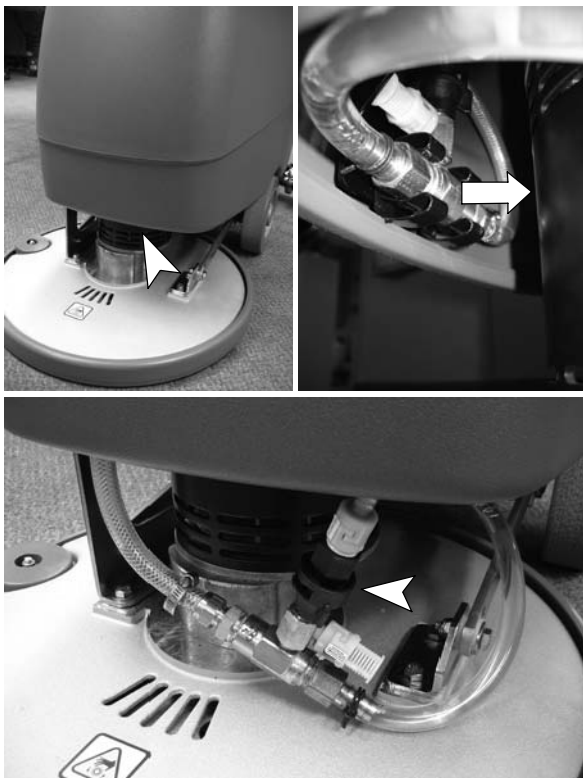

**FIG. 50**

2. Unthread the black plastic filter housing and clean or replace the orifice plate and filter (Figure 51).

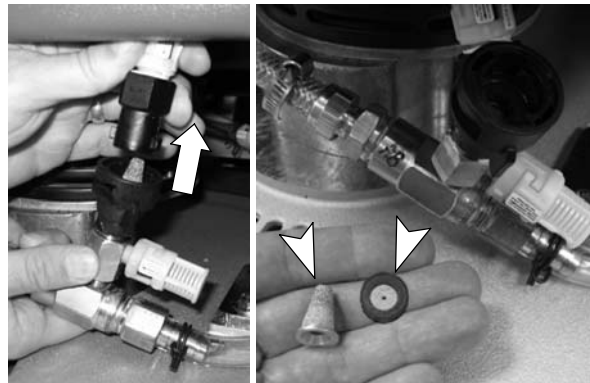
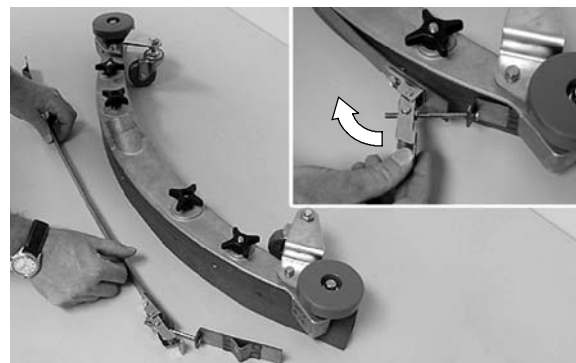

**FIG. 51**

**SQUEEGEE BLADE REPLACEMENT**

Each squeegee blade has four wiping edges. When the blades become worn, simply rotate the blades end-for-end or top-to-bottom for a new wiping edge. Replace blade if all four edges are worn.

1. Remove the squeegee assembly from the machine.
2. Loosen the band clamp and remove the band from the squeegee assembly (Figure 52).



**FIG. 52**

3. Rotate the rear blade to a new wiping edge and reinstall the band. Make sure the notched edge of the band is facing downward (Figure 53).

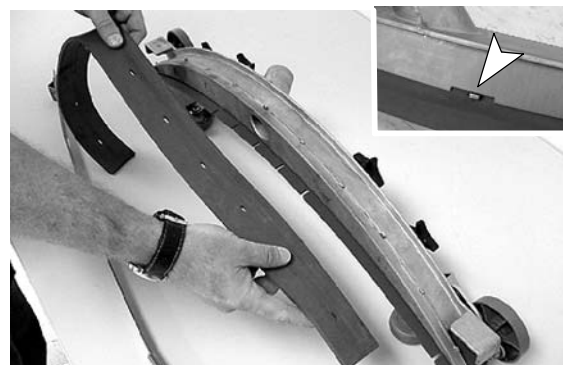

**FIG. 53**

- To replace the front blade, remove the rear band and fully loosen the four squeegee assembly knobs, do not remove the knobs. Lift and tilt the retainer plate to access the front blade (Figure 54). Rotate the front blade to a new wiping edge and return the retainer plate. Make sure the retainer plate tabs engage the blade slots. Reinstall the band then retighten the knobs.

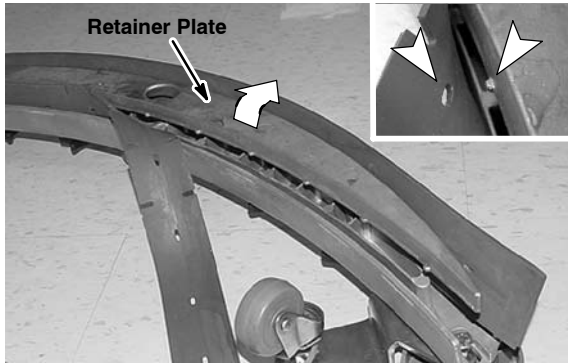

FIG. 54

### SQUEEGEE BLADE ADJUSTMENT

For optimum squeegee blade performance, the squeegee assembly casters must be adjusted to a specified height as described below.

- To check the squeegee assembly for proper adjustment, remove the squeegee assembly from the machine and place it on a level surface. Measure the distance between the caster and the surface. It should measure approximately 3 mm (Figure 55).
- To adjust the caster height, loosen the top nut and remove the plastic bearing cover to access the adjustment nut. Turn the adjustment nut until properly adjusted (Figure 55). After adjusting, tighten the top nut and replace the plastic bearing cover. Repeat step for the other caster.

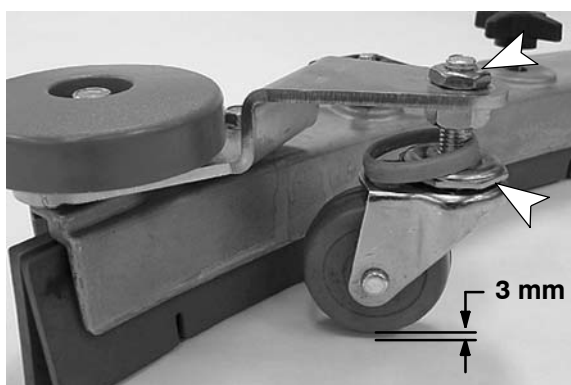

FIG. 55

- During machine operation, with the casters properly adjusted, the squeegee blades should deflect as shown (Figure 56).

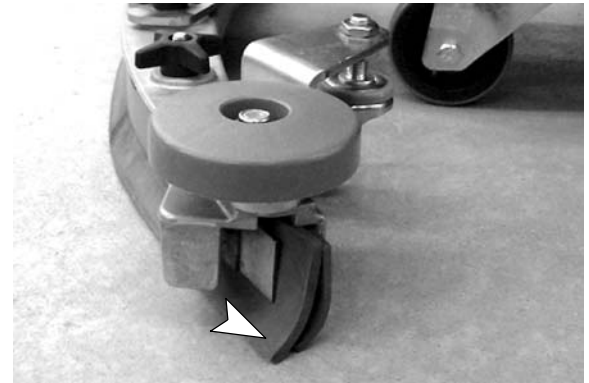

FIG. 56

### BATTERY MAINTENANCE (Lead Acid Batteries)

**⚠ WARNING: Fire Or Explosion Hazard. Batteries Emit Hydrogen Gas. Keep Sparks And Open Flame Away. Keep Battery Compartment Open When Charging.**

**FOR SAFETY: When servicing machine, wear protective gloves and eye protection when handling batteries and battery cables. Avoid contact with battery acid.**

- Check the specific gravity using a hydrometer to determine the charge level and the condition of the batteries (Figure 57). If one or more of the battery cells read lower than the other battery cells (0.050 or more), the cell is damaged, shorted, or is about to fail. Check the hydrometer readings against the following chart to determine the remaining battery charge level.

**NOTE: Do not take readings immediately after adding distilled water. If the water and acid are not thoroughly mixed, the readings may not be accurate.**

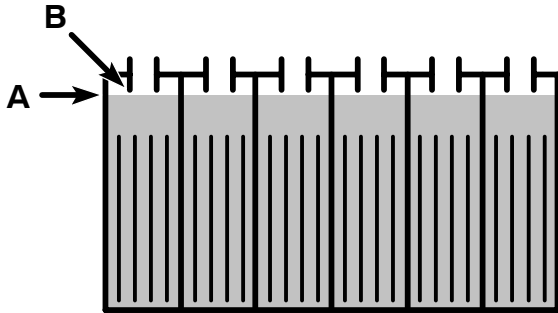

FIG. 57

SPECIFIC GRAVITY at 27° C	BATTERY CHARGE
1.265	100% CHARGED
1.223	75% CHARGED
1.185	50% CHARGED
1.148	25% CHARGED
1.110	DISCHARGED

**NOTE:** If the readings are taken when the battery electrolyte is any temperature other than 27°C, the reading must be temperature corrected. Add or subtract to the specific gravity reading 0.004, 4 points, for each 6°C above or below 27°C.

2. Always follow proper charging instructions (See CHARGING BATTERIES).
3. Check the electrolyte level (A) in each battery cell **after charging batteries**. The level should be approximately 1 cm from the bottom of the fill-port (B). Add distilled water if needed (Figure 58). **DO NOT OVERFILL.**



**FIG. 58**

4. Keep the battery tops clean to prevent battery corrosion.  
To clean batteries:

**FOR SAFETY:** When servicing machine, wear protective gloves and eye protection when handling batteries and battery cables. Avoid contact with battery acid.

- a. Mix a strong solution of baking soda and water (Figure 59).



**FIG. 59**

- b. Brush the solution sparingly over the battery tops and cable connectors.

**NOTE:** Do not allow baking soda solution to enter battery cells.

- c. Use a wire brush to clean the battery terminals and cable connectors.
  - d. After cleaning, apply a coating of clear battery post protectant to the terminals and cable connectors.
5. Check for loose or worn cables. Replace if worn.

**BRUSH MOTOR BELT REPLACEMENT  
(50 cm DUAL DISK MODEL)**

**⚠ WARNING: Electrical Hazard. Disconnect Battery Cables Before Servicing Machine.**

1. Disconnect the scrub head lift arm mounting brackets from the scrub head, 13 mm wrench required (Figure 60).

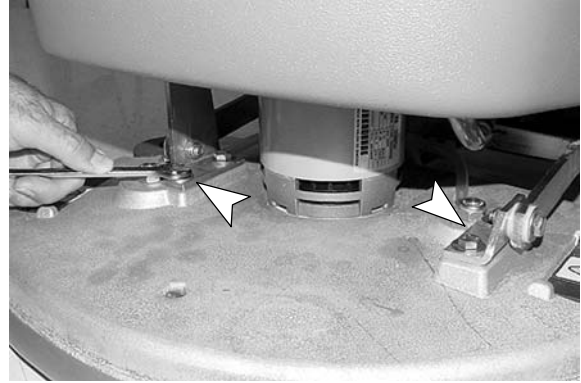

**FIG. 60**

2. Unplug the brush motor wire connector and disconnect the solution feed hose (Figure 61).

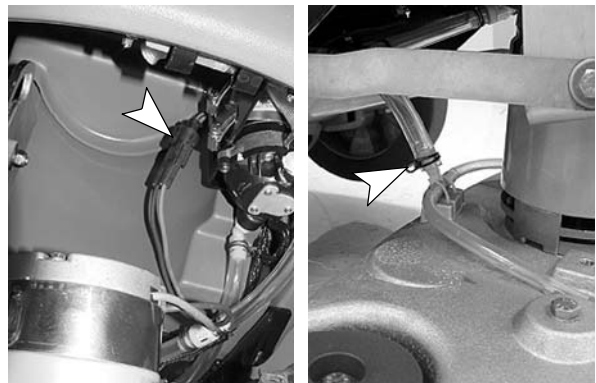

**FIG. 61**

3. Remove the scrub head from the machine (Figure 62).



**FIG. 62**

- Carefully lay the scrub head bottom side up and remove the belt cover, 10 mm wrench required (Figure 63).

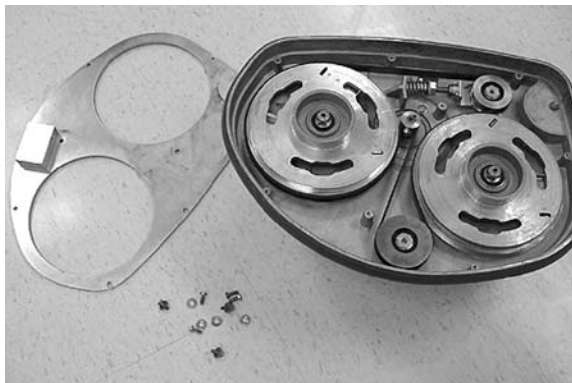

FIG. 63

- To replace the belt, completely loosen the belt tension bolt and install the new belt as shown (Figure 64). Match the groove side of the belt to the grooved pulleys.

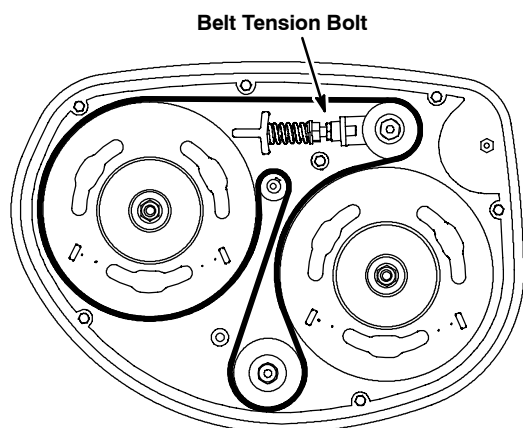

FIG. 64

- To properly adjust the belt tension, turn the belt tension bolt until the tension spring is compressed to a length of 35mm (Figure 65). Tighten the tension bolt jam nut after adjusting.

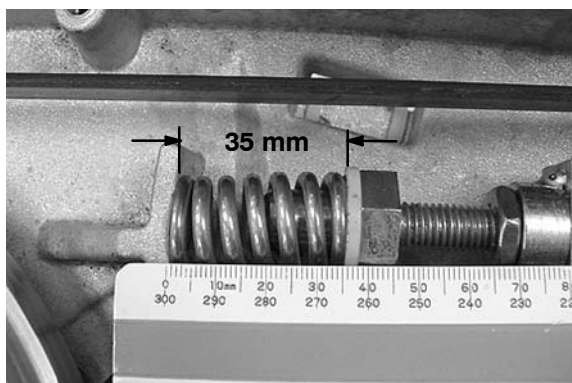

FIG. 65

- After the first 50 hours of use, recheck the belt for proper tension.

## TRANSPORTING MACHINE

When transporting the machine by use of trailer or truck, be certain to follow the tie-down procedure below:

- Raise the squeegee and scrub head.
- Load the machine using a recommended loading ramp.
- Position the front of machine up against the front of the trailer or truck. Once the machine is positioned, lower the scrub head and squeegee.
- Set the parking brake and place a block behind each wheel to prevent the machine from rolling.
- Place tie-down straps over the top of machine to prevent it from tipping. It may be necessary to install tie-down brackets to the floor of your trailer or truck.

**FOR SAFETY: When transporting machine, use a recommended ramp when loading/unloading into/off truck or trailer. Use tie-down straps to secure machine to truck or trailer.**

## STORING MACHINE

- Charge the batteries before storing. Never store the machine with discharged batteries.
- Drain and rinse the tanks thoroughly.
- Store the machine in a dry area with the squeegee and scrub head in the up position.
- Open the recovery tank cover to promote air circulation.

**ATTENTION: Do not expose machine to rain, store indoors.**

- If storing machine in freezing temperatures, make sure to drain machine of all water.

For models equipped with the FaST System, follow the FaST SYSTEM FREEZE PROTECTION procedure below.

**FaST SYSTEM FREEZE PROTECTION (FaST Model)**

Valve Coupling #1002856 and 15 cm Hose #63182 are required (Purchased separately).

1. Disconnect the FaST-PAK from the FaST system and route the supply hose down to the scrub head (Figure 66).

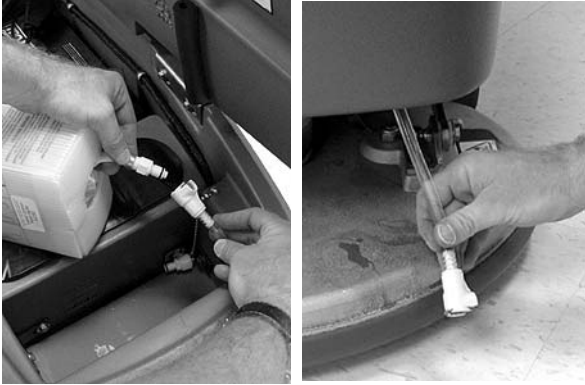

**FIG. 66**

2. Connect the valve coupling (purchased part) to the supply hose and drain the remaining concentrate into a small container (Figure 67). Squeeze the supply hose several times if the concentrate does not flow.

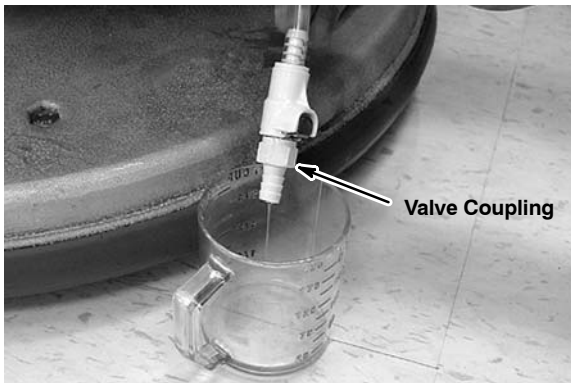

**FIG. 67**

3. Route the supply hose back up to the FaST-PAK compartment. Connect the 15 cm hose (purchased part) to the valve coupling and pour RV anti-freeze into the hose until full (Figure 68). Squeeze the supply hose several times if the anti-freeze does not flow.

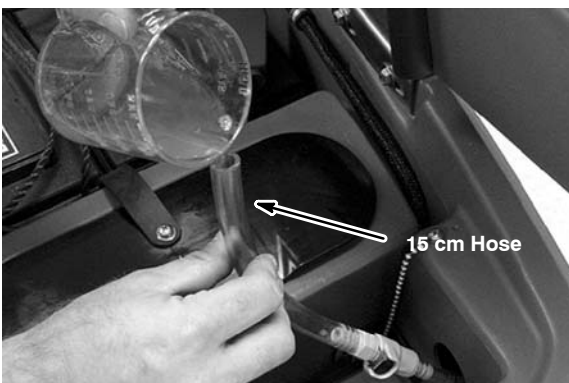

**FIG. 68**

4. Keep the hose upright to prevent the Anti-freeze from spilling and lower the recovery tank.
5. Operate the FaST system until the foaming stops. This step could take anywhere from 5- 10 minutes.
6. Drain the solution tank.
7. Remove the valve coupling and connect the supply hose to the storage plug (Figure 69).

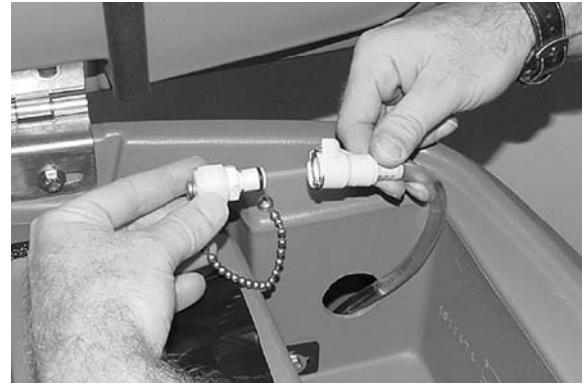

**FIG. 69**

8. To drain the anti-freeze, repeat the draining process above and reconnect the supply hose to the FaST-PAK.

**RECOMMENDED STOCK ITEMS**

Refer to the Parts List Manual for recommended stock items. Stock Items are clearly identified with a bullet preceding the parts description. See example below:

Ref.	Part No.	Description	Qty.
1	701103	ASM.,STANDPIPE	1
2	180613	•FLOAT, SHUTOFF	1
3	230197	NIPPLE	1
4	101714	•GASKET	1
5	210240	NUT, FLANGED	1

## TROUBLESHOOTING

PROBLEM	CAUSE	SOLUTION
Machine will not operate	Discharged batteries	Charge batteries
	Emergency-stop button activated	Turn button clockwise to reset
	Faulty battery(s)	Replace battery(s)
	Loose battery cable	Tighten loose cable
	Main fuse blown	Replace fuse
	Faulty key switch	Contact Service Center
Brush motor will not operate	Scrub head is raised off floor	Lower scrub head
	Battery meter lockout activated	Recharge batteries
	Tripped brush motor circuit breaker	Reset brush circuit breaker button
	Faulty scrub head (up/down) switch	Contact Service Center
	Faulty Control handle bail switch	Contact Service Center
	Faulty brush motor or wiring	Contact Service Center
	Worn carbon brushes	Contact Service Center
	Broken or loose belt (50cm model)	Replace or tighten belt
Machine does not propel (50cm Dual Disk model with drive)	Parking brake is set	Release parking brake lever
	Main fuse blown	Replace 30 Amp fuse
	Faulty relay switch	Contact Service Center
	Faulty transaxle motor or wiring	Contact Service Center
	Worn carbon brushes	Contact Service Center
Vacuum motor will not operate	Squeegee is raised off floor	Lower squeegee
	Vacuum motor fuse blown	Replace 25 Amp fuse
	Faulty vacuum motor or wiring	Contact Service Center
	Worn carbon brushes	Contact Service Center
FaST Model: FaST System does not operate or operate correctly	FaST system switch is not turned on	Turn on FaST system switch
	FaST-PAK supply hose not connected	Connect supply hose
	FaST Pump fuse blown	Replace 7.5 Amp fuse
	Clogged FaST-PAK supply hose or connectors	Soak in warm water to unclog
	Empty FaST-PAK carton	Replace FaST PAK carton
	Kink in FaST-PAK supply hose	Undo hose kink
	Clogged FaST solution system	Contact Service Center
	Faulty FaST system on/off switch	Contact Service Center
	Faulty pump	Contact Service Center
	Clogged solution tank filter	Drain solution tank. remove solution tank filter, clean and reinstall
	Clogged orifice/filter screen	Replace orifice/filter screen (See ANNUAL MAINTENANCE)
	Little or no solution flow (Conventional Scrubbing)	Clogged solution tank filter or solution hose
Clogged solution valve		Remove valve and clean
Solution flow control knob set too low		Adjust solution control flow knob
Loose screw on control knob		Calibrate knob and retighten screw

**TROUBLESHOOTING - Continued**

<b>PROBLEM</b>	<b>CAUSE</b>	<b>SOLUTION</b>
Poor water pickup	Recovery tank is full	Drain recovery tank
	Loose drain hose cap	Tighten cap
	Clogged float shut-off screen located in recovery tank	Clean screen
	Clogged squeegee assembly	Clean squeegee assembly
	Worn squeegee blades	Replace or rotate squeegee blades
	Incorrect Squeegee blade deflection	Adjust Squeegee blade height
	Loose vacuum hose connections	Secure hose connections
	Clogged vacuum hose	Remove clogged debris
	Damaged vacuum hose	Replace vacuum hose
	Recovery tank cover not in place	Properly position cover
	Damaged recovery tank cover seal	Replace seal
	Faulty vacuum motor	Contact Service Center
	Low battery charge	Recharge batteries.
Short run time	Batteries not fully charged	Fully recharge batteries
	Defective batteries	Replace battery
	Service batteries	See BATTERY MAINTENANCE
	Faulty battery charger	Repair or replace battery charger

**LED FAULT CODES (Drive Model Battery Meter Display)**

<b>CODE (Flashing LED Bars)</b>	<b>FAULT</b>	<b>SOLUTION</b>
One	Low voltage shut-off. Scrubbing function stops.	Recharge batteries.
		Check battery connection.
Two	Battery charge level getting low.	Recharge batteries.
Three	Drive motor tripped.	Remove overload condition and reset key.
	Short circuit to drive motor.	Contact Service Center.
Four	Battery lockout.	Recharge batteries immediately.
Eight	Controller tripped.	Contact Service Center.
Ten	High battery voltage reading	Check battery connections.
No Bars	Sleep mode	Turn key to restore.
Bars Rippling	Throttle engaged.	Release activation bail.

## SPECIFICATIONS

MODEL	T3 43 cm Single Disk	T3 50 cm Dual Disk with Drive
LENGTH	1128 mm	1167 mm
WIDTH	486 mm	517 mm
HEIGHT	1093 mm	1093 mm
WEIGHT	100 Kg / 143 Kg with batteries	101 Kg / 144 Kg with batteries
RECOVERY TANK CAPACITY	40 L	40 L
SOLUTION TANK CAPACITY	40 L	40 L
DRIVE SYSTEM	N/A	Transaxle, 24 V, 0.104 Kw
PRODUCTIVITY RATE - AVG.	888 m <sup>2</sup> per hour (FaST Model)	1691m <sup>2</sup> per hour (FaST Model)
	784 m <sup>2</sup> per hour	1492m <sup>2</sup> per hour
CLEANING PATH WIDTH	430 mm	500 mm
PAD PRESSURE	18.9 Kg	18.59 Kg
SQUEEGEE WIDTH	763 mm	763 mm
BRUSH MOTOR	0.373 Kw, 220 rpm, 24 V, 20 A	0.224 Kw, 2600 rpm, 24 V, 12 A
VACUUM MOTOR	350 W, 2-stage 5.7, 24 V, 13 A	350W, 2-stage 5.7, 24 V, 13 A
WATER LIFT	100 Mbar	100 Mbar
BATTERIES	Two - 12 V	Two - 12 V
RUN TIME PER CHARGE	Up to 2.5 hours	Up to 3.25 hours
TOTAL POWER CONSUMPTION	32 Amp nominal	28 Amp nominal
VOLTAGE DC	24 VDC	24 VDC
BATTERY CAPACITY	110 Ah / 5hr Rate	110 Ah / 5hr Rate
PROTECTION GRADE	IPX3	IPX3
SOUND POWER LEVEL	68 dB (1m x 1m)	68 dB (1m x 1m)
DECIBEL RATING AT OPERATOR'S EAR, INDOORS.	68.5 dB(A)	68.5 dB(A)
VIBRATIONS AT HAND CONTROLS	<2.5m/s <sup>2</sup>	<2.5m/s <sup>2</sup>
MAXIMUM GRADE LEVEL	8% (5°) Transporting 5% (3°) Cleaning	8% (5°) Transporting 5% (3°) Cleaning

<b>FaST SYSTEM - FaST MODEL</b>	
SOLUTION PUMP	24 Volt DC, 3.5 A, 5.6 LPM open flow, 4.13 Bar bypass setting
SOLUTION FLOW RATE	0.47 LPM
CONCENTRATE FLOW RATE	0.47 CC/Minute
CONCENTRATE TO WATER DILUTION RATIO	1:1000



MACHINE DIMENSIONS

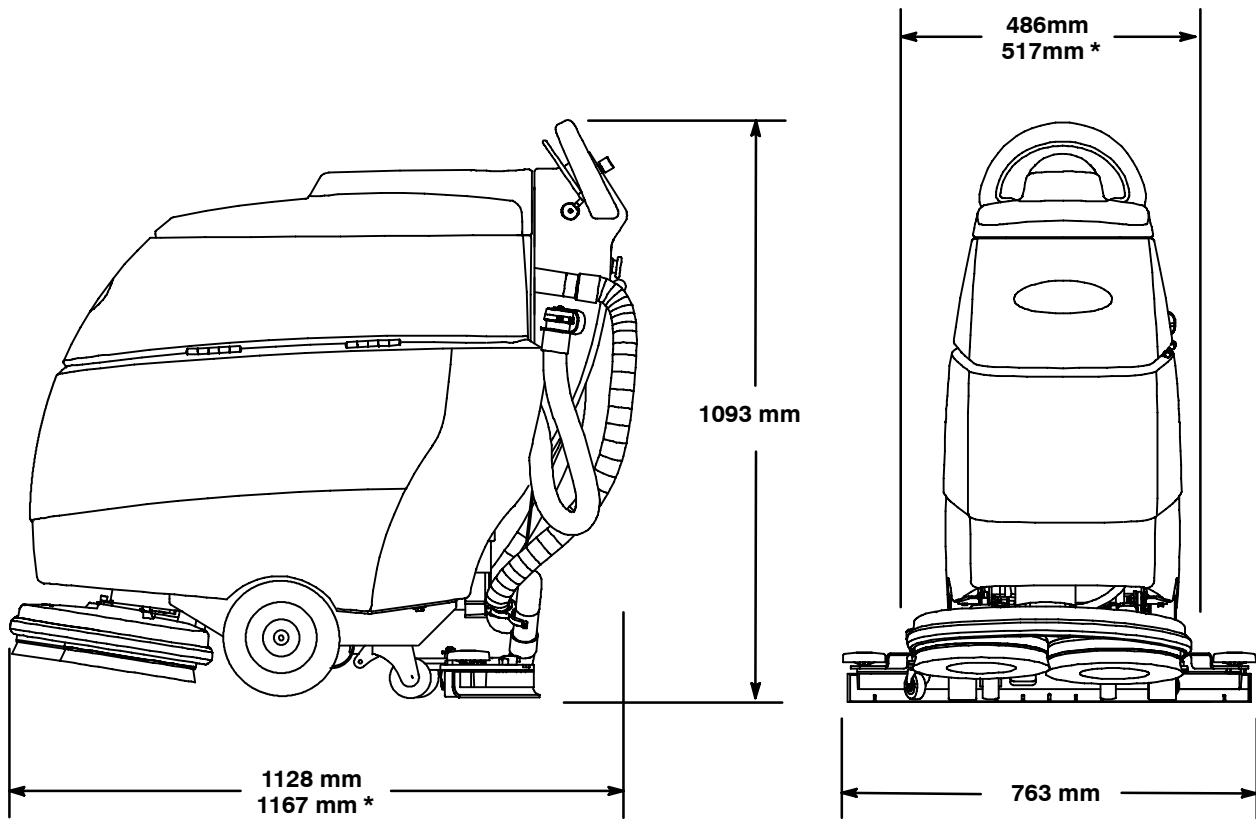

\* 50 cm Dual Disk Model